

Malö B

Byggyta: 595 x 887 cm

Yttermått: 575 x 867 cm · Väggtjocklek: 58 mm

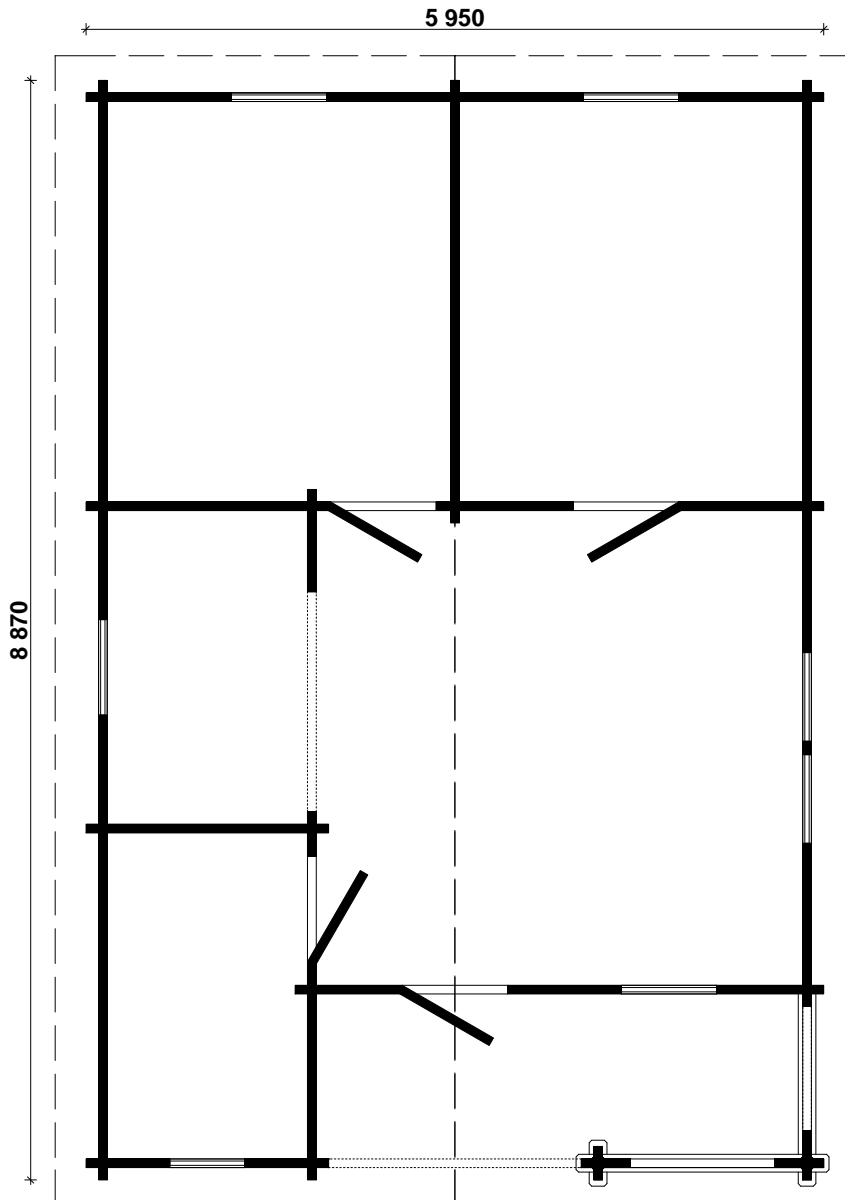



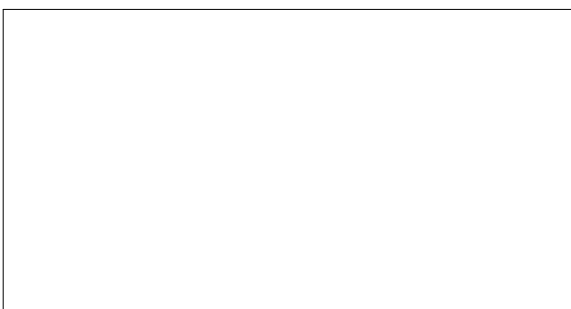

2090

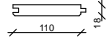
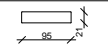
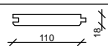
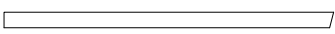
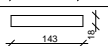
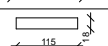
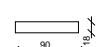

OBS: 18 mm golvbrädor !



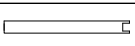
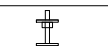
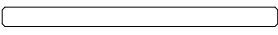
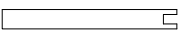

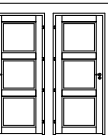
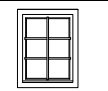
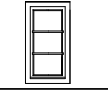
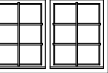





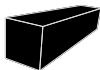

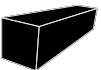
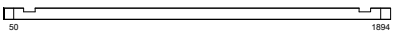
Obs! Alla mått är ungefärliga.

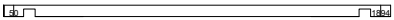
Nr.	Beskrivning	Profil mm	Längd mm	Antal	
EX01	Grundreglar	70 x 60	5720	3	
EX02			5215	5	
EX03			3936	4	
EX04			3810	7	
EX05			3215	12	
EX06	Golvbrädor		2785	60	
EX07			5630	28+1	
EX08			3945	6	
EX09			1625	21	
EX10	Terassbrädor		1410	40	
EX11	Takbrädor		3350	170+2	
EX12	Takfotsbrädor 		3400	4	
EX13			3400	4	
EX14	Gavelbrädor		3400	4	
EX15	Takkanter		4635	4	
EX16	Takkanter		3090	6	
EX17	Romb			2	
EX18	Lister		ca. 52,0 m		
EX19	Takpapp		--	--	
EX20	Stolpe 	70 x 90	1090	2	
EX21	Justerbar stolpfot 			2	
EX22	Stormpelare	∅ 10	2200/800	7/2	
EX23	Muttrar, brickor			18	
EX24	Pluggar	∅ 16	150	90	
EX25	Räcke 	40 x 143	2040	1	
EX26				1305	1
EX27				115	3
EX28	Skruvar 4,0 x 40, 5,0 x 100,			1 Bag	
EX29	Spikar 2,2 x 50			1 Bag	
EX30	Hit block	58 x 114	300-400		
EX31	Dörr 890 x 2090 mm / 58 mm - L			1	
EX32	Dörr 890 x 2090 mm / 58 mm - R+L			3(1+2)	
EX33	Fönster 765 x 990 mm - DG 58 mm			4	
EX34	Fönster 600x1100 mm - DG 58 mm			1	
EX35	Dubbelt fönster 1530 x 990 mm - DG 58 mm			1	

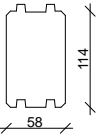
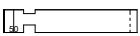

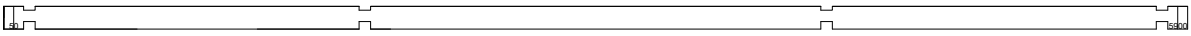
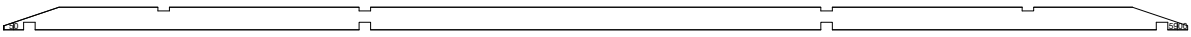
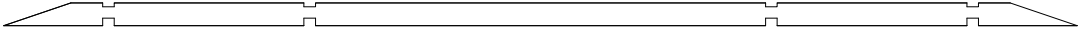
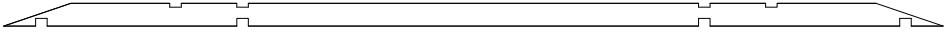
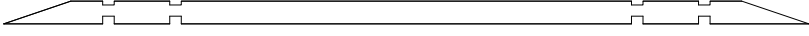

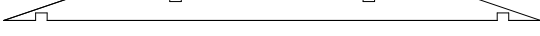
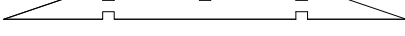
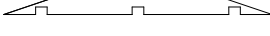
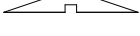

Malö

2090

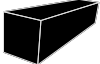
Nr.		 mm	 mm	 x	
A01			1944	2	
A02			1944	1	
A03			1944	10	
A04			670	20	
A05			400	6	
A06			5950	1	
A07			5950	1	
A08			5395	1	
A09			4721	1	
A10			4046	1	
A11			3372	1	
A12			2698	1	
A13			2023	1	
A14			1349	1	
A15			674	1	

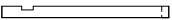
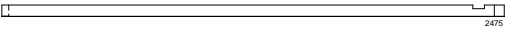
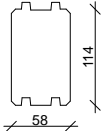
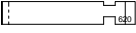

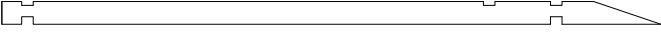







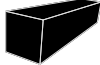
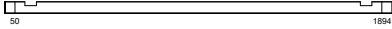

Malö

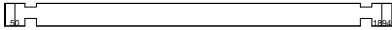
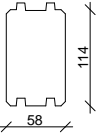
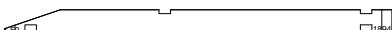
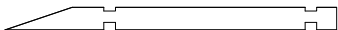
2090

Nr.		 mm	 mm	 x	
B01			839	1	
B02			2525	1	
B03			839	18	
B04			2525	9	
B05			670	9	
B06			1085	9	
B07			4264	1	
B08			3987	1	
B09			3649	1	
B10			3312	1	
B11			2975	1	
B12			2638	1	
B13			2023	1	
B14			1349	1	
B15			674	1	

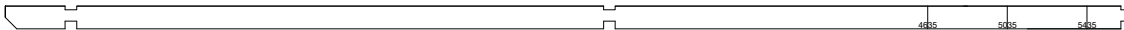
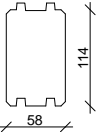
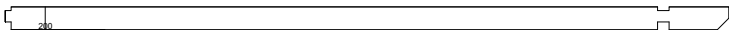
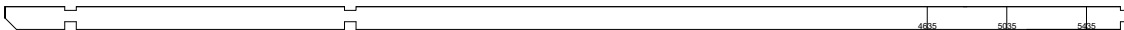

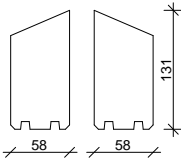
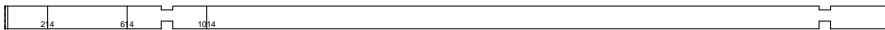











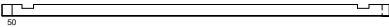
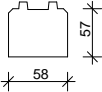
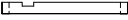
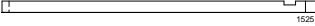

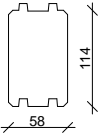
Malö

2090

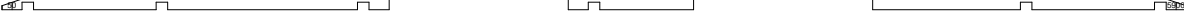
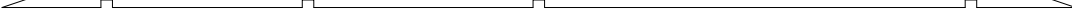
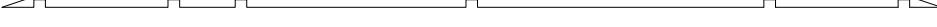
Nr.		 mm	 mm	 x
C01			1944	1
C02			1944	18
C03			1944	1
C04			1667	1
C05			1329	1
C06			992	1
C07			655	1
C08			318	1
DB01			5635	2
DB02			3635	6
DB03			5635	4
DB04			1000	6
DB05			4835	2(2+0)
DB06			4435+14	6(3+3)
DB07			4835	4(1+3)

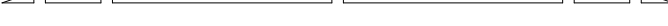
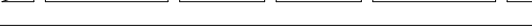









Malö

2090

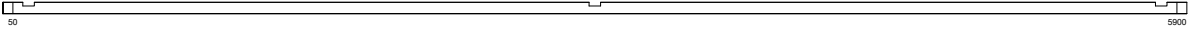
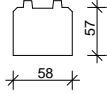
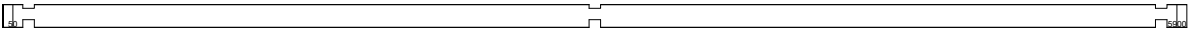
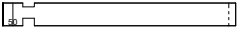
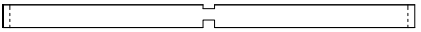
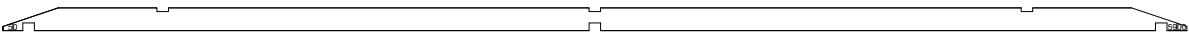
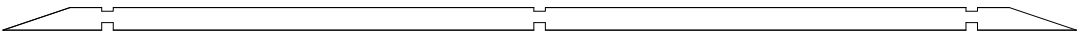
Nr.		 mm	 mm	 x
D01			1945	1
D02			630	1
D03			1575	1
D04			1945	17
D05			630	18
D06			1575	17
D07			1945	1
D08			1575	1
D09			5950	1
D10			5395	1
D11			4721	1
D12			4046	1
D13			3372	1
D14			2698	1
D15			2023	1
D16			1349	1
D17			674	1



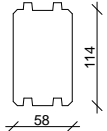
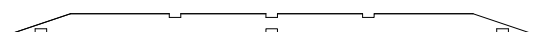

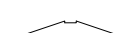





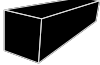

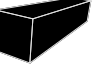
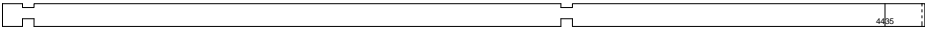
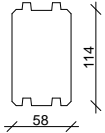
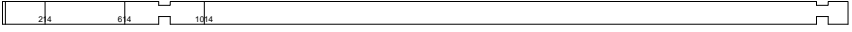

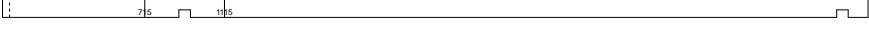

Malö

2090

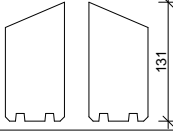
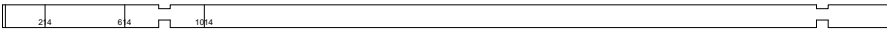
Nr.		 mm	 mm	 x
E01			5950	1
E02			5950	9
E03			1170	18
E04			2070	9
E05			5950	1
E06			5395	1
E07			4721	1
E08			4046	1
E09			3372	1
E10			2698	1
E11			2023	1
E12			1349	1
E13			674	1

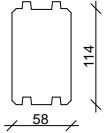

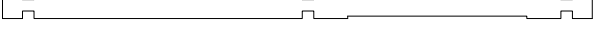
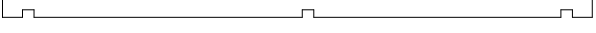

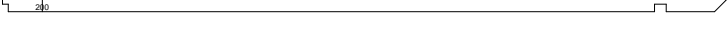









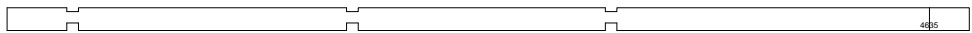
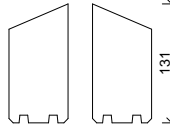
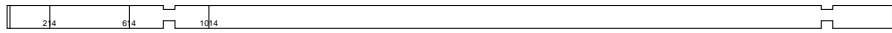

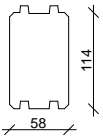
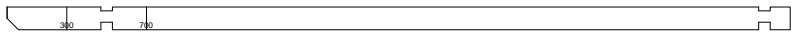
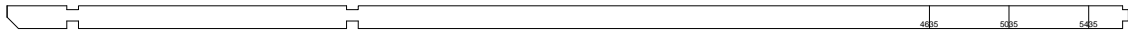
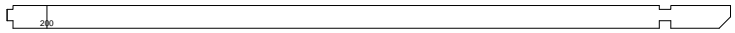
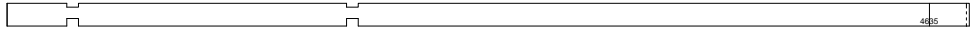
Malö

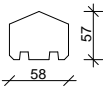
2090

Nr.		 mm	 mm	 x	
101			4635	4	
102			4235+14	4	
103			5435	4	
104			3435	4	
105			3750	9	
106			4350	1	
107			5635	1	
108			3635	1	
109				4835	1(1+0)
110				4435+14	1(1+0)
201			1735	19	
202			329	19	
203			818	21	
204			2964	1	
205			2964	3	
206			5935	1	
207			5635	1	
208			3635	1	

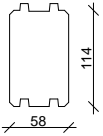



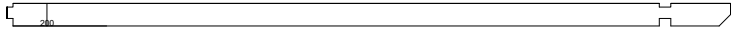





Malö

2090

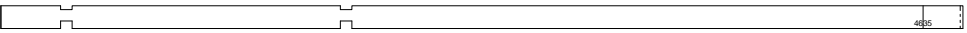
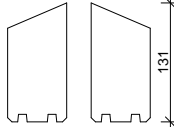
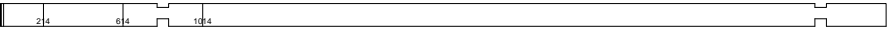
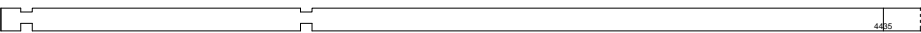
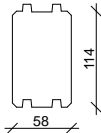
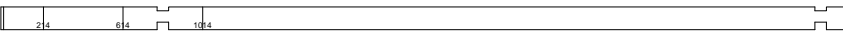
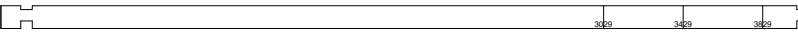
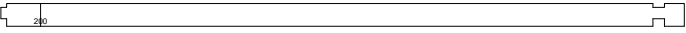
Nr.		 mm	 mm	 x
209			4835	1(1+0)
210				4435+14
301			3564	24
302			3935	1
303			5635	1
304			3635	1
305			4835	1
306			4435+14	1
307			5635	1
308			3635	1
401			258	1
402			258	10
403			258	1
404			1000	1
405			5635	1
406			3635	1

Malö

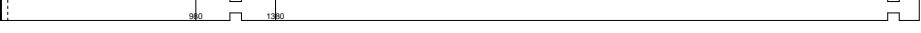
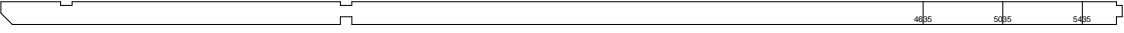
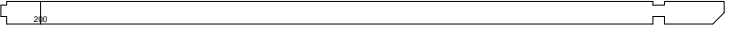
2090

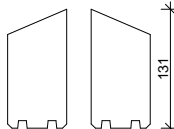
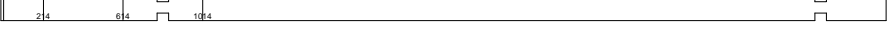
Nr.		 mm	 mm	 x
407			4835	1(0+1)
408			4435+14	1(0+1)
501			4635	3
502			4235+14	4
503			4029	4
504			3435	4
505			400	3
506			4635	1
507			1309	9
508			4615	9
509			5635	1
510			3635	1
511			4835	1(0+1)
512			4435+14	1(0+1)

Malö - Grund

2090

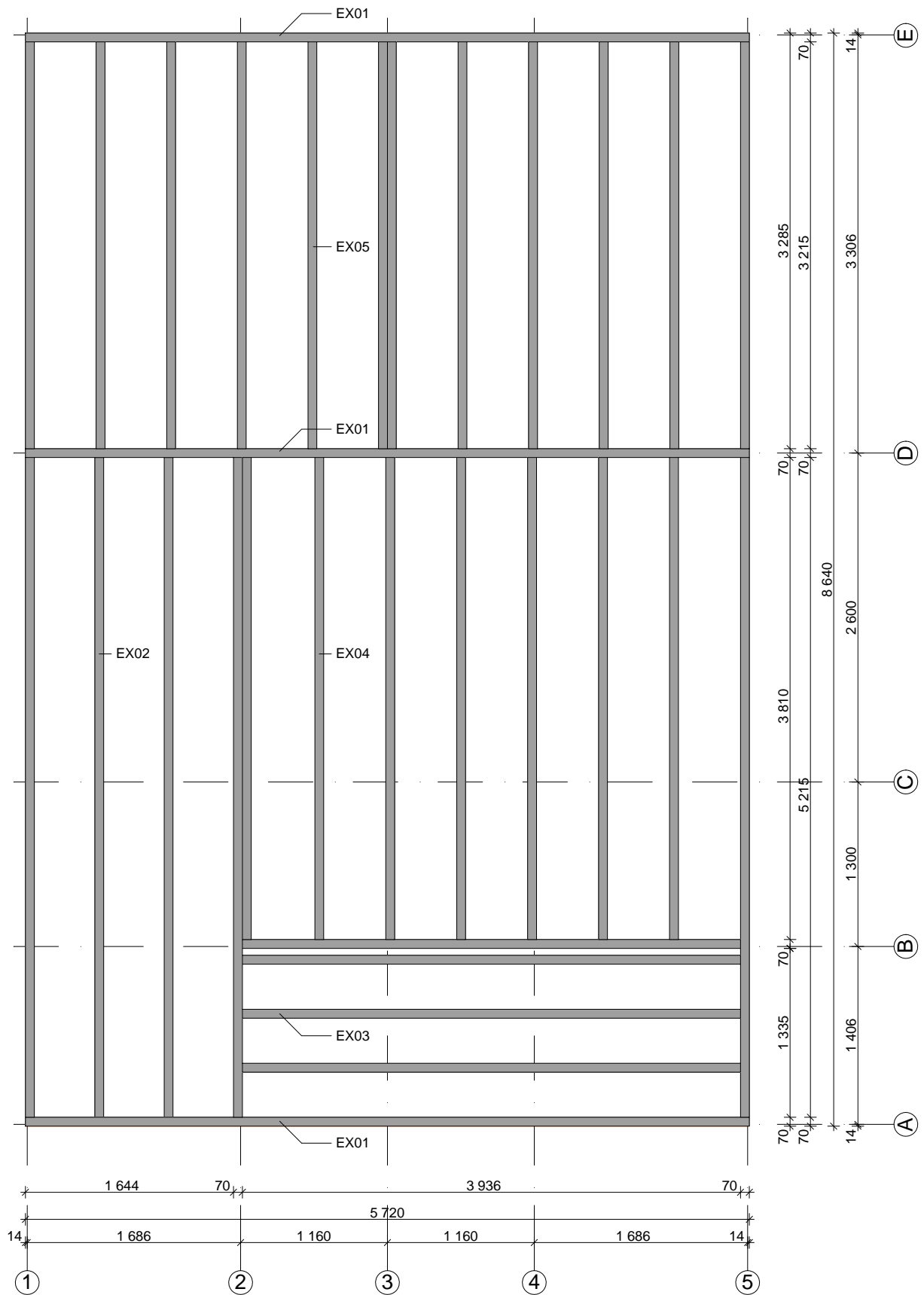

Malö - Markplan

2090

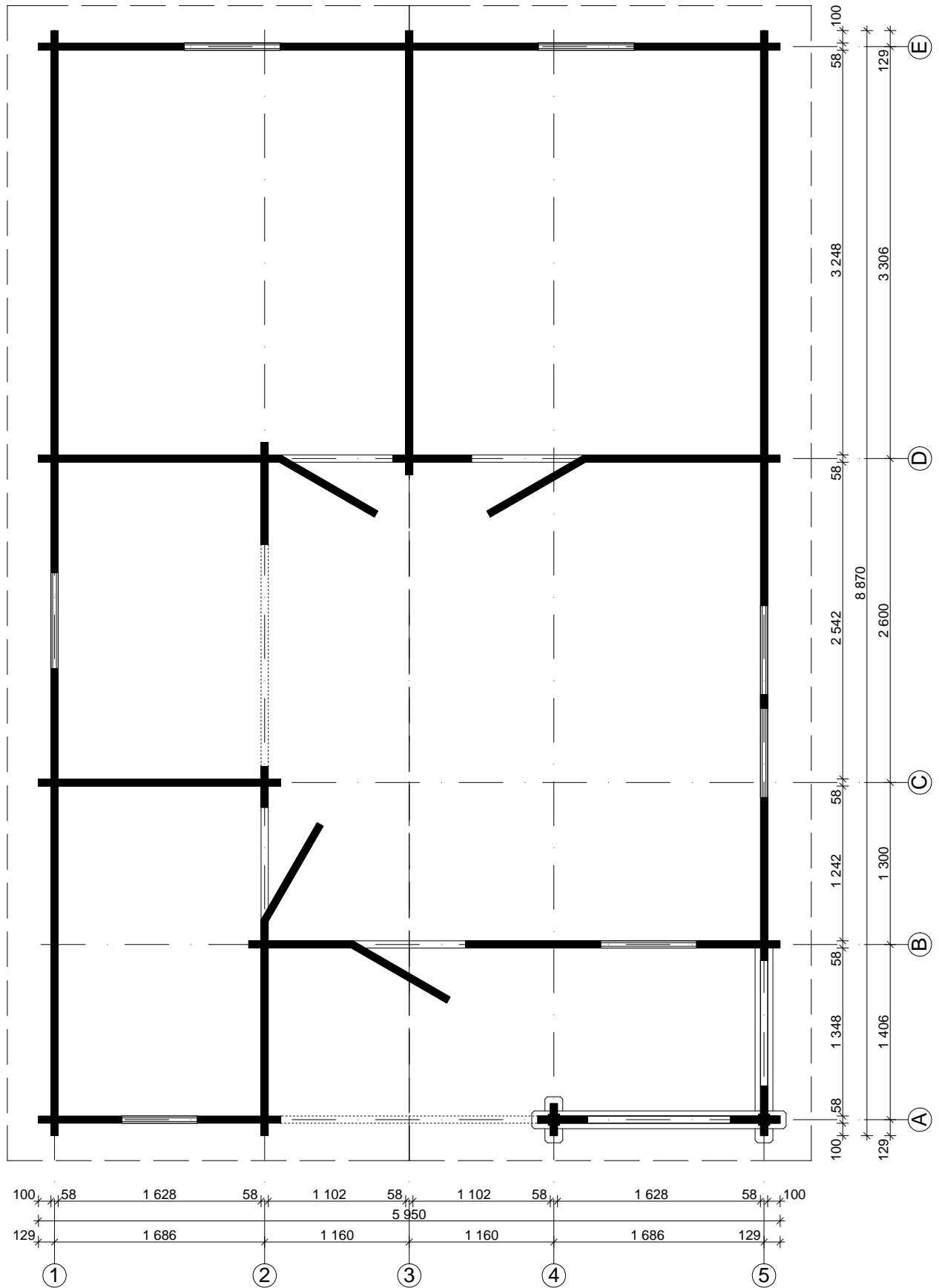

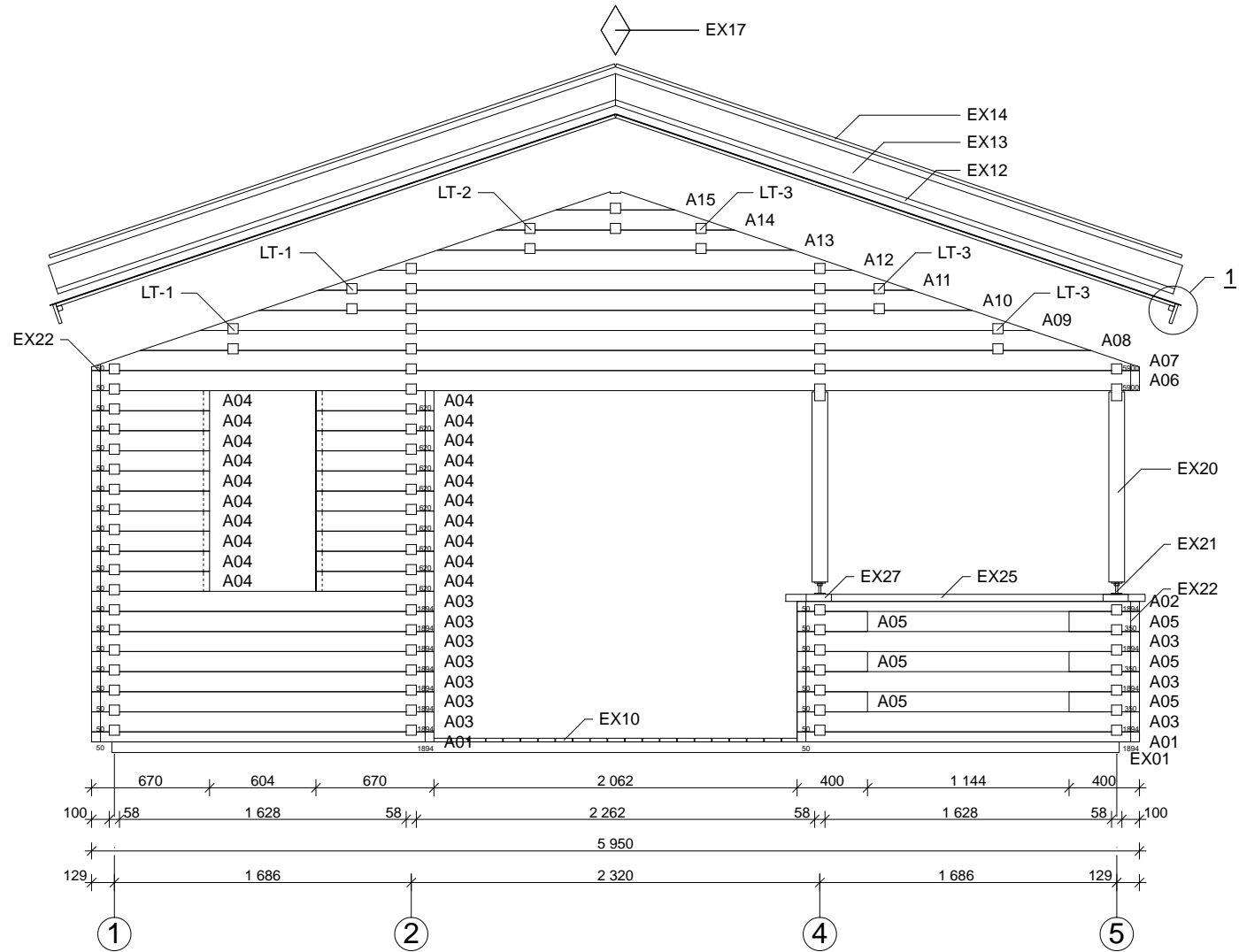

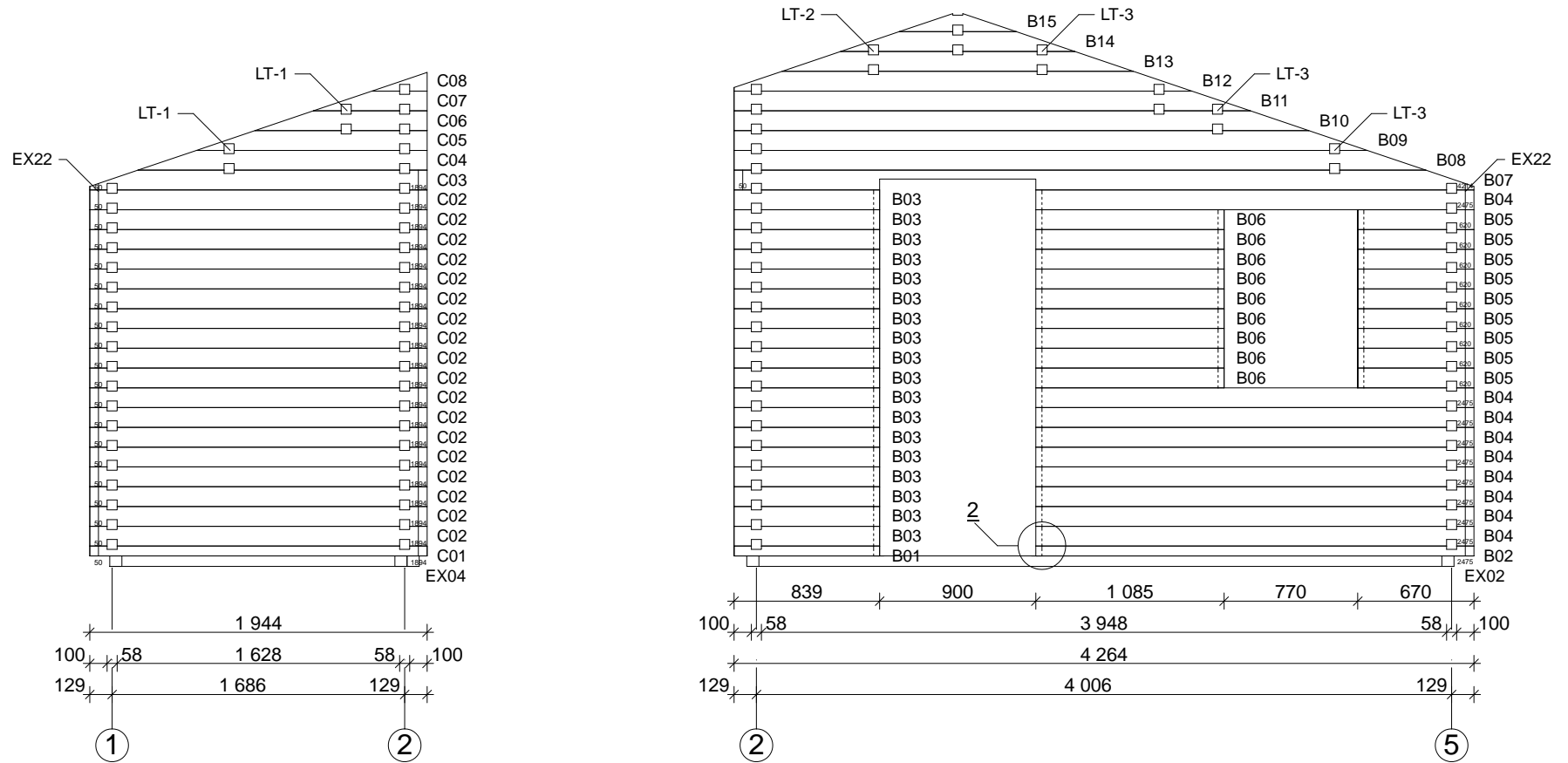

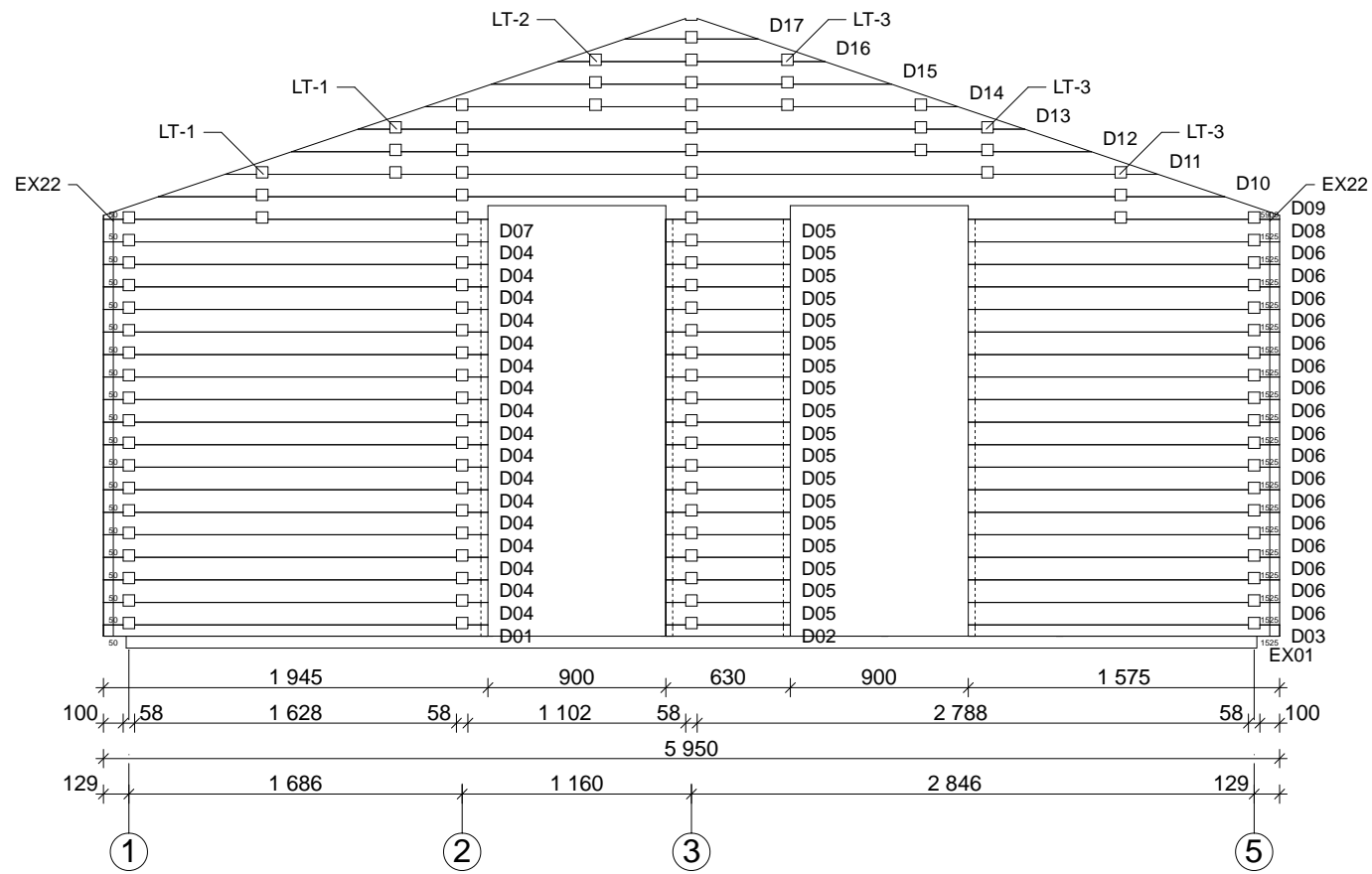

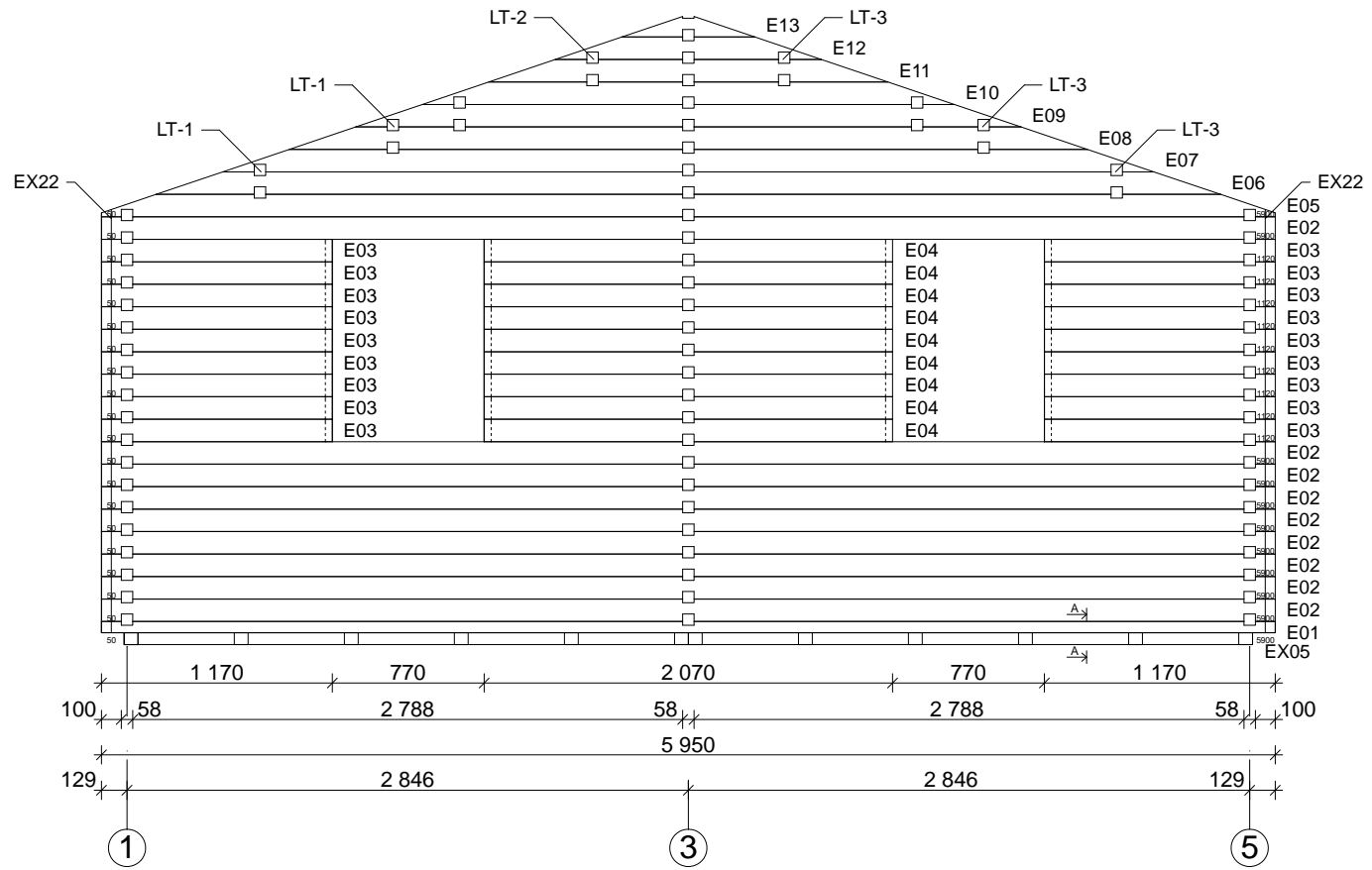

Malö

2090

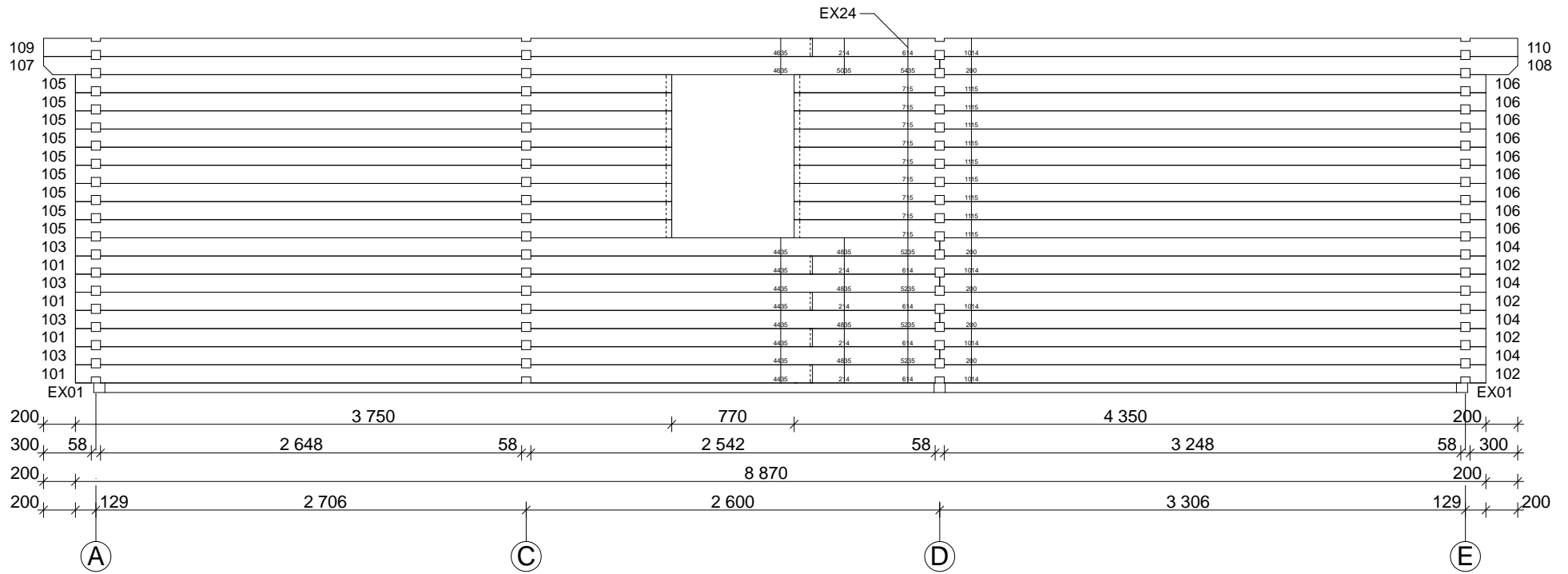

Malö

2090

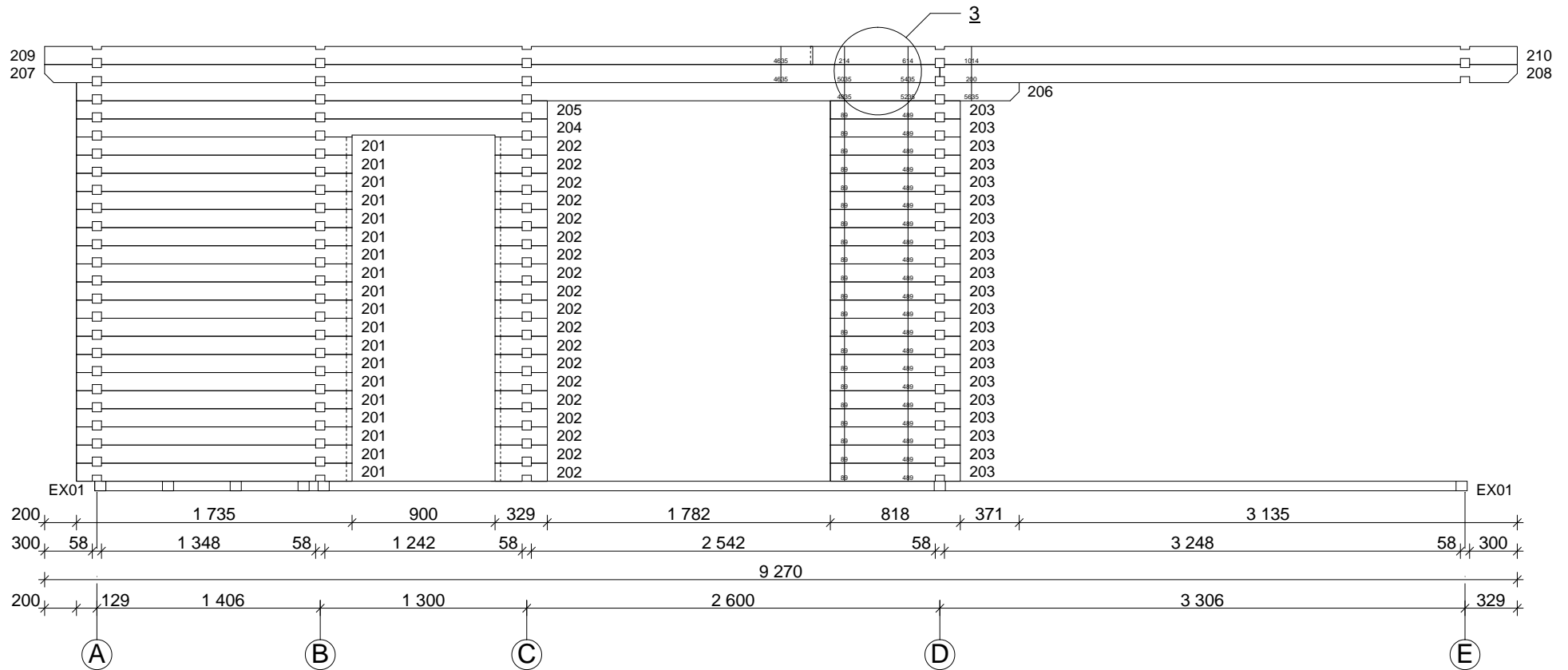

Malö

2090

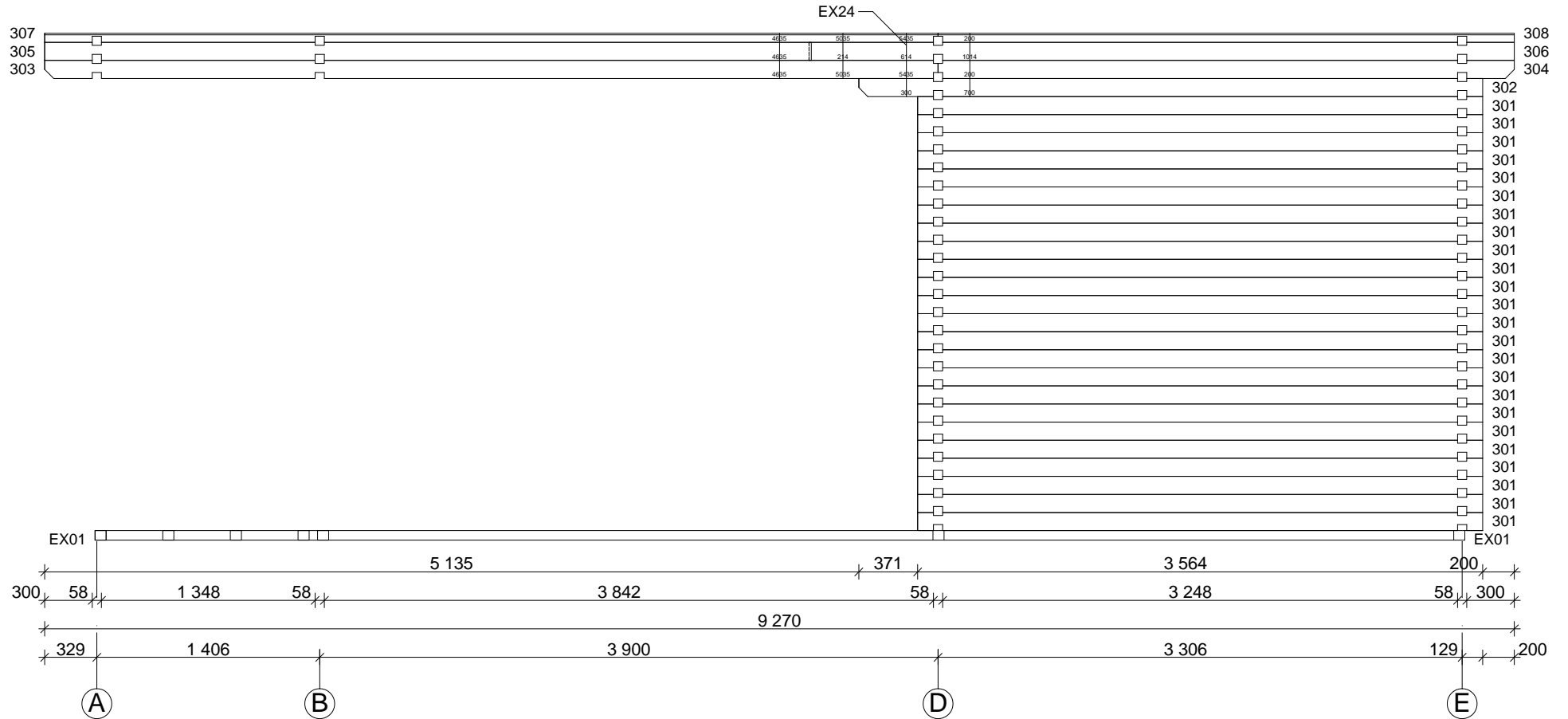

Malö

2090

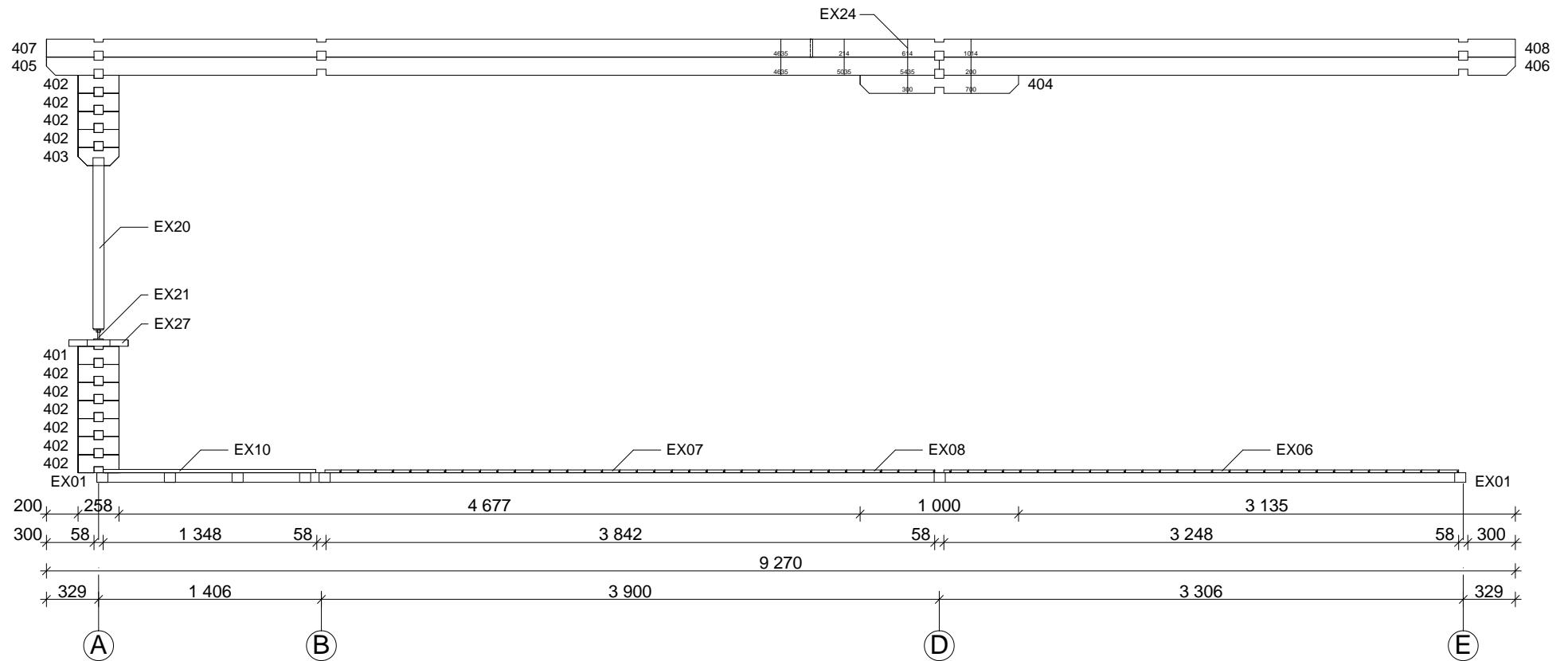

Malö

2090

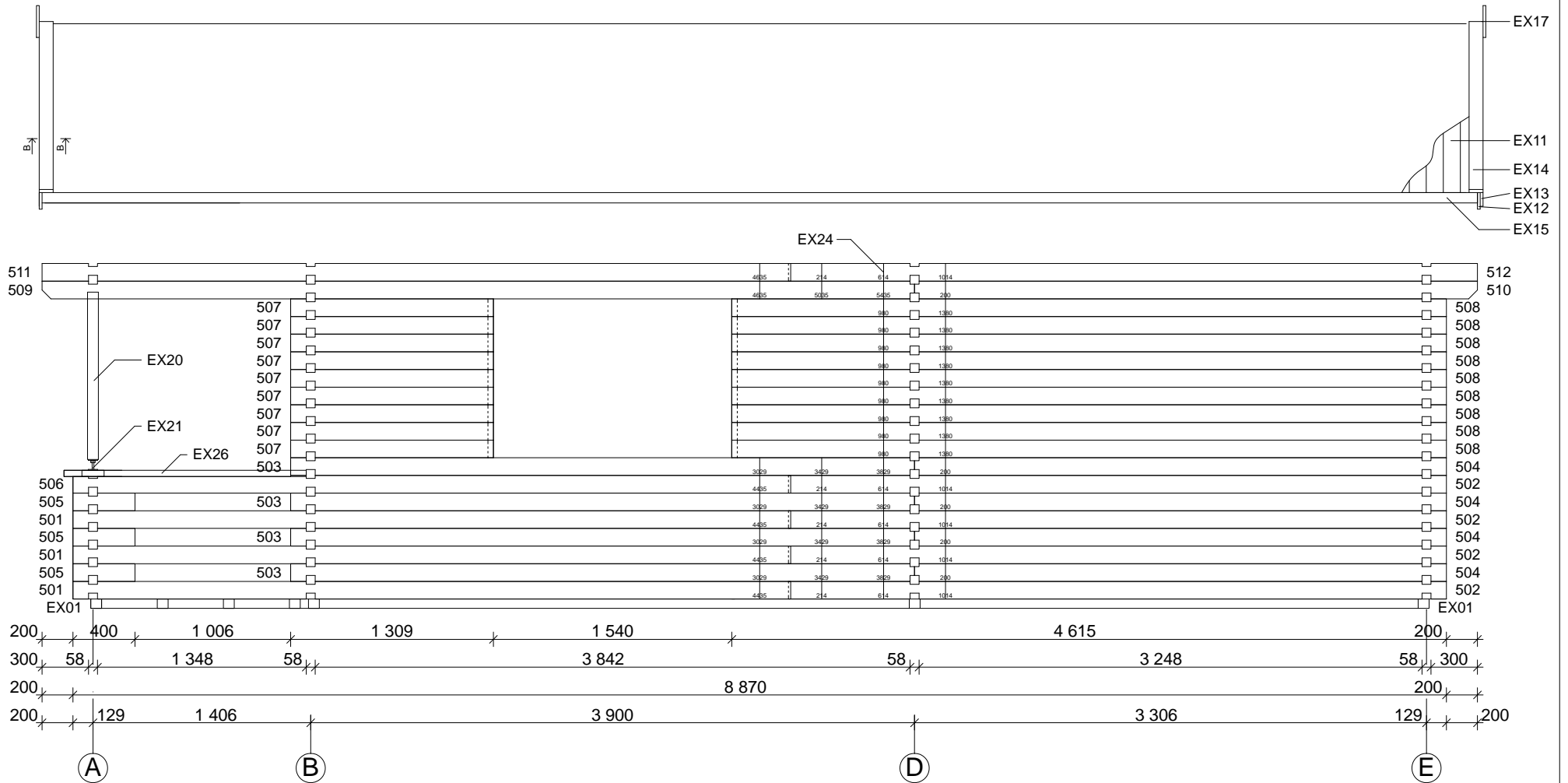

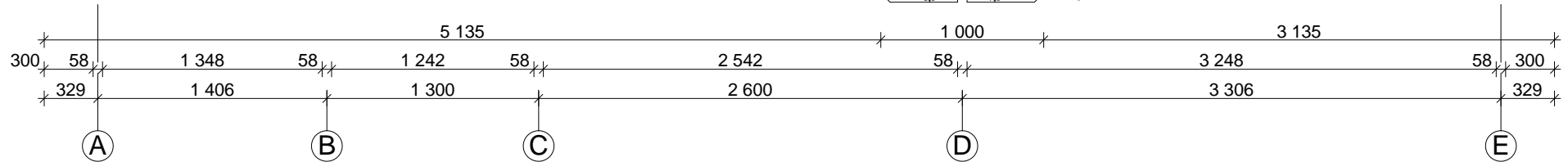
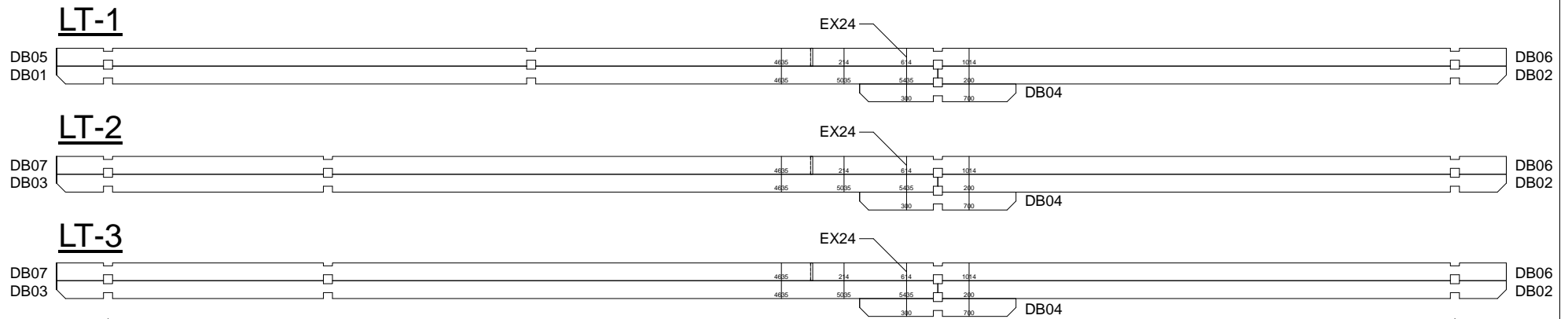

A-A

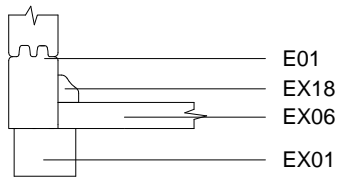

1

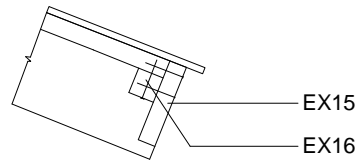

3

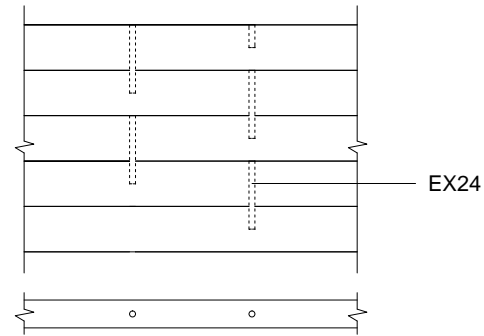

2

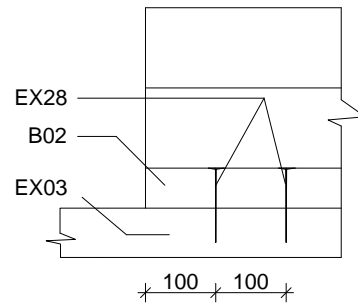

4

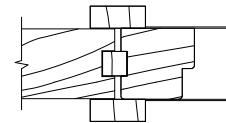

4

