

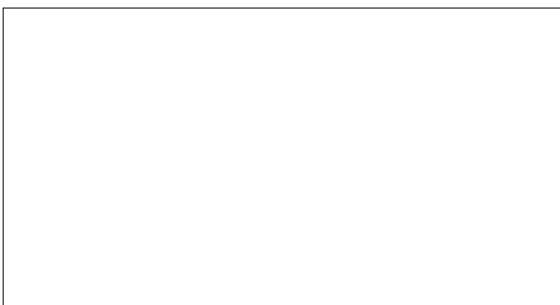

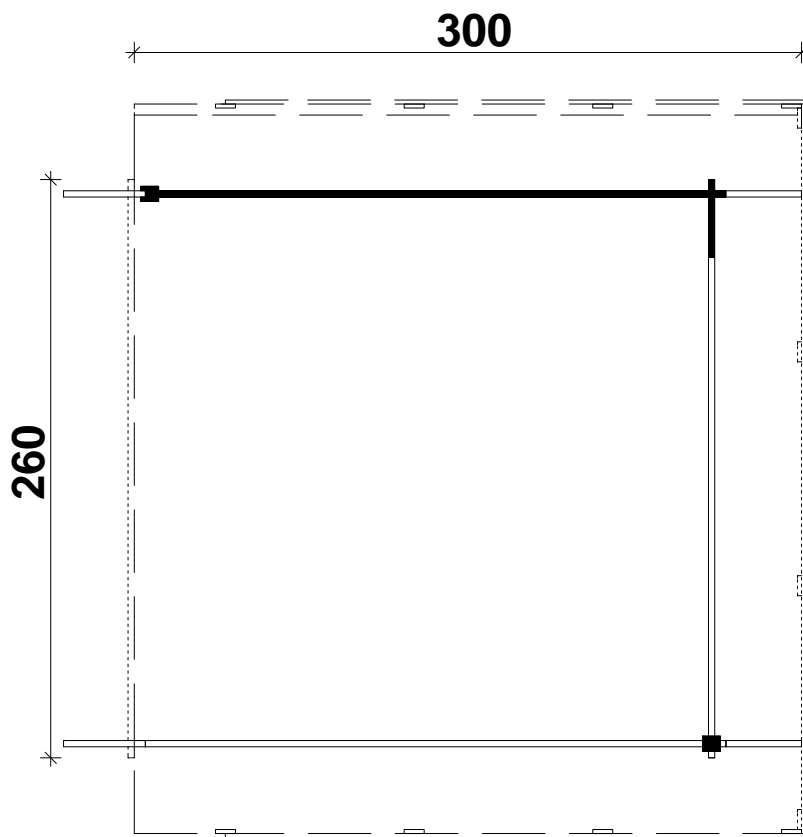







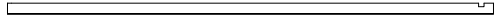





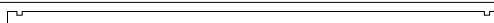
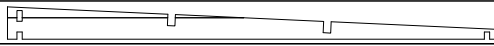

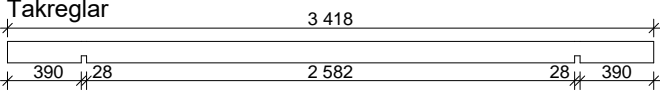
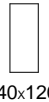
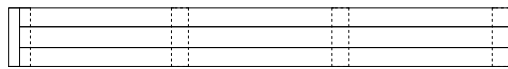
Viskan 3B

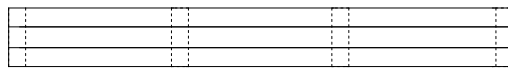
Byggyta: 300 x 260 cm Väggtjocklek: 28 mm



OBS! Alla mått är ungefärliga.

Viskan 3B

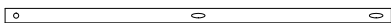
| Nr | Beskrivning | Profil mm | Längd mm | Antal |
|----|---|--|----------|----------|
| 1 | Grundreglar | 45x70 | 2610 | 1 |
| 2 | | | 255 | 1 |
| 3 |  |  | 2570 | 1 |
| 4 |  |  | 2570 | 16 |
| 5 |  | | 2978 | 2 |
| 6 |  | | 350 | 17 |
| 7 |  | | 2600 | 1 |
| 8 |  | | 2600 | 1 |
| 9 |  |  | 3014 | 2 |
| 10 | Takreglar  |  | 3418 | 2 |
| 11 | Blenden  |  | 2610 | 2(1+1) |
| 12 | Blenden  | | -- | -- |
| 13 | Takpapp | | -- | -- |
| 14 | Takbrädor |  | 3230 | -- |
| | |  | 3230 | 28 |
| 15 |  | 45x70 | 390 | 6 |
| 16 | Takpappsplåt | 20x40 | 3000 | 1 |
| 17 | Stolpe  |  | 1990 | 1 |
| 18 | Stolpe  | | 1895 | 1 |
| 19 | Reglerbart stolpstöd  | | | 1 |
| 20 | Stormlist  | 20x40 | 2010 | 2 |
| 21 | Skruv 4,0 x 40 | | | 1 Beutel |
| 22 | Spik 2,5 x 50 | | | 1 Beutel |
| 23 | Takpappsspik 3,0 x 15 | | | -- |
| 24 | Skruv 4,5 x 70 | | | 1 Beutel |
| 25 | Bult M 8 x 60, Mutter, Brickor | | | 6 |
| 26 | List | 18x115 | 210 | 3 |
| 27 | Slagbitar | | 300-400 | |

Viskan 3B

Vägg A

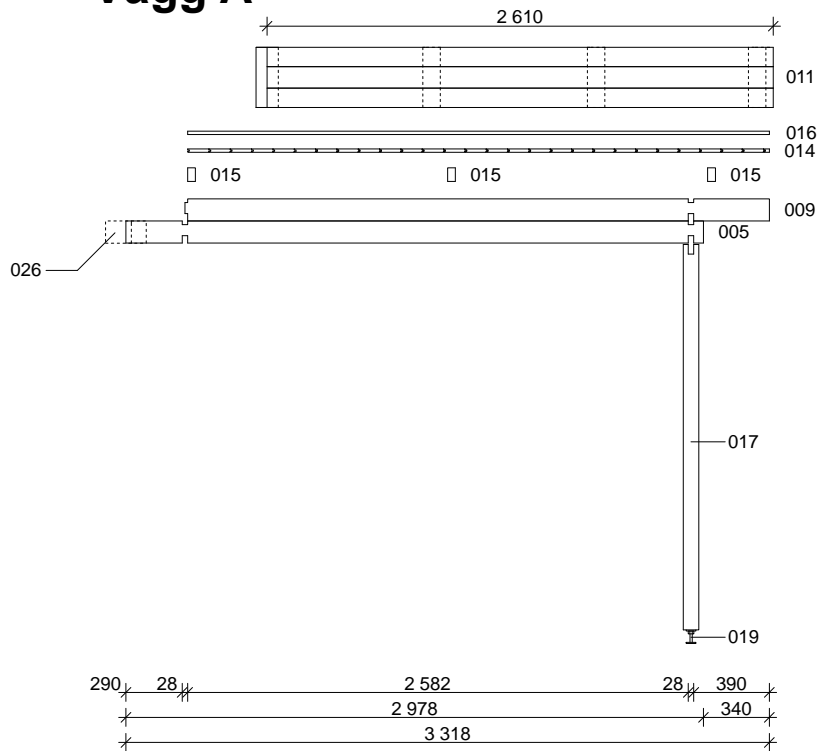

Vägg B

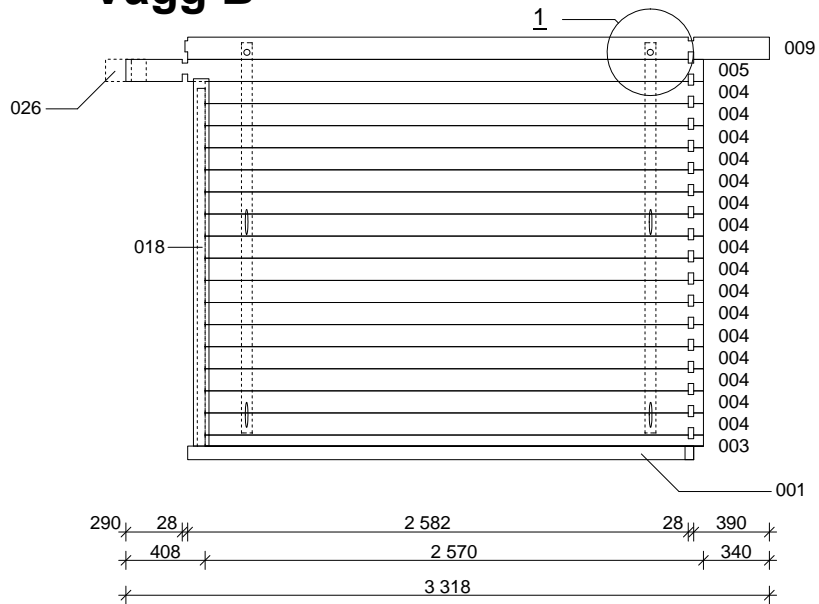

1

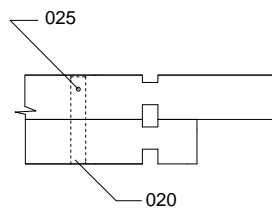

Viskan 3B

Vägg C

