

Malcolm A

1/5

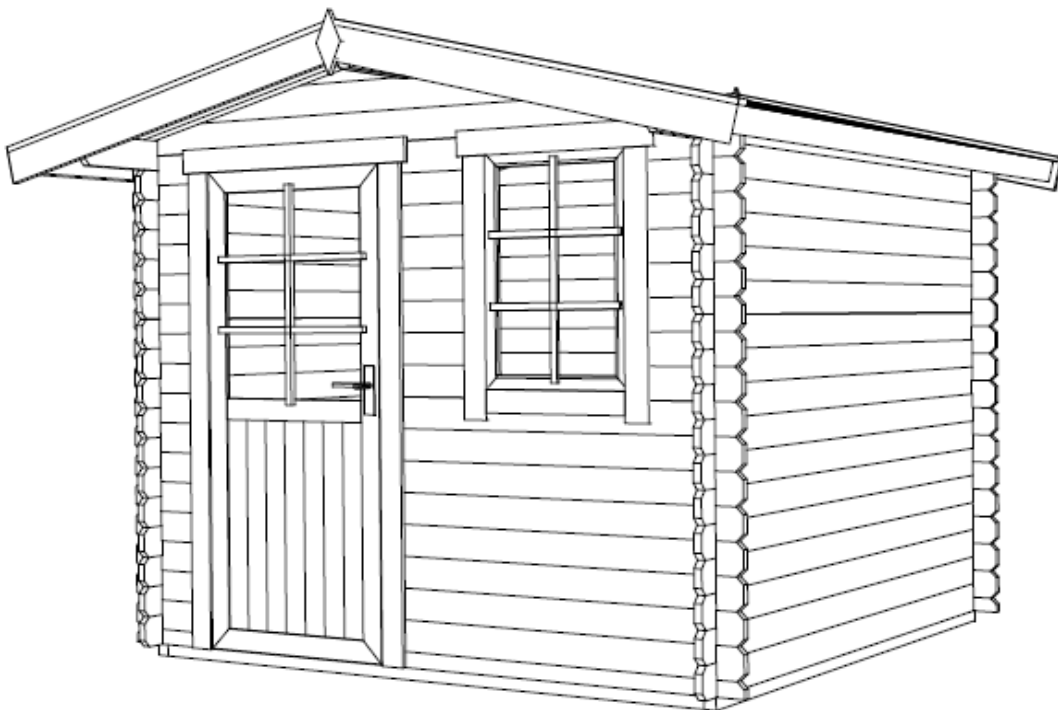

GROUNDPLAN - GRUNDPLAN - PLAN DE MASSE

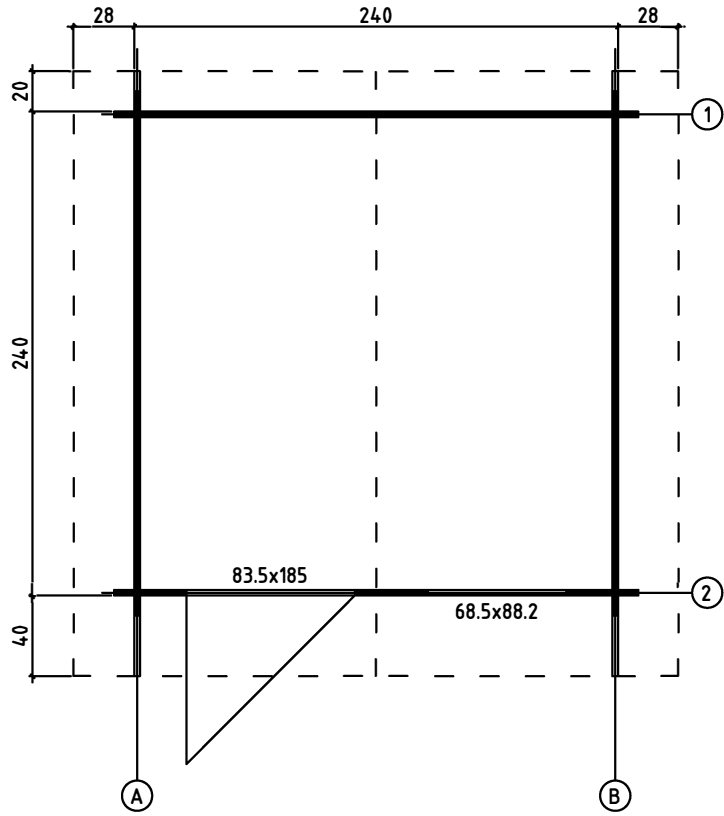



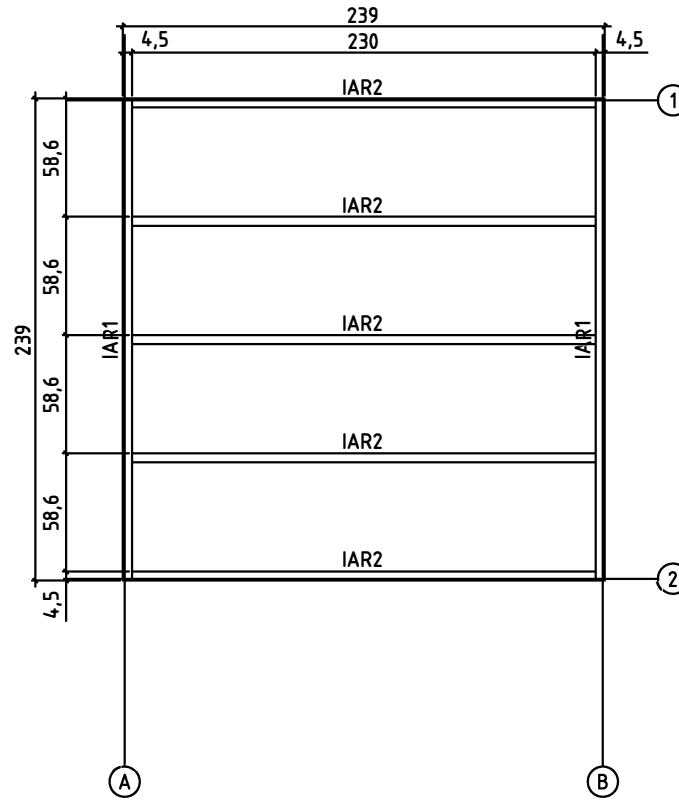



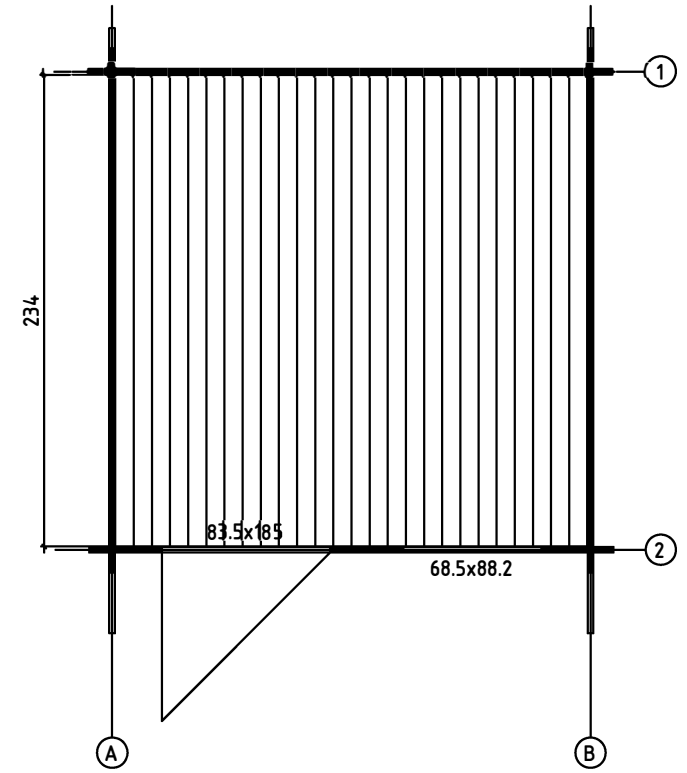

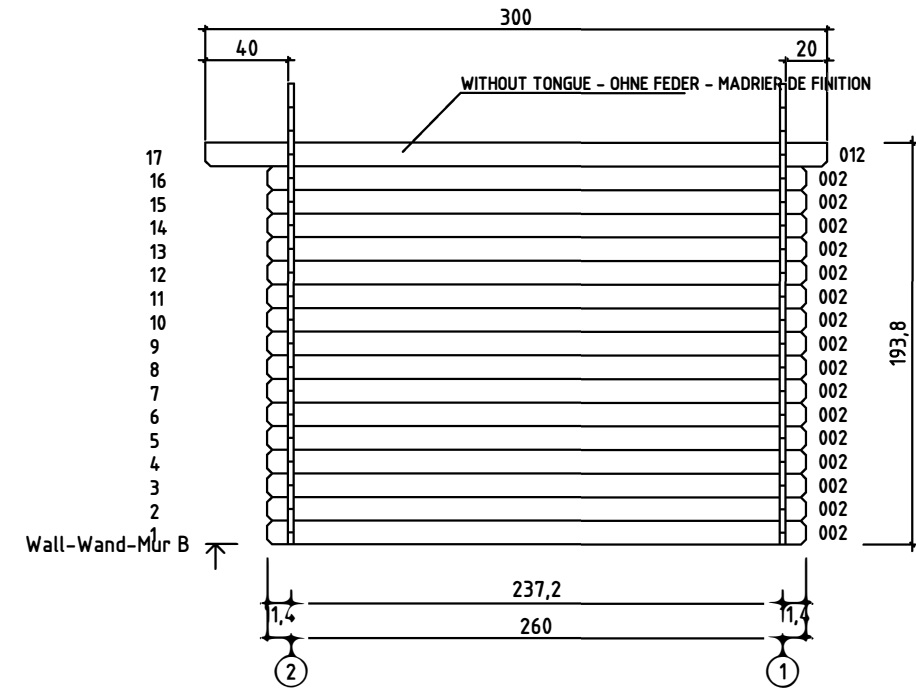
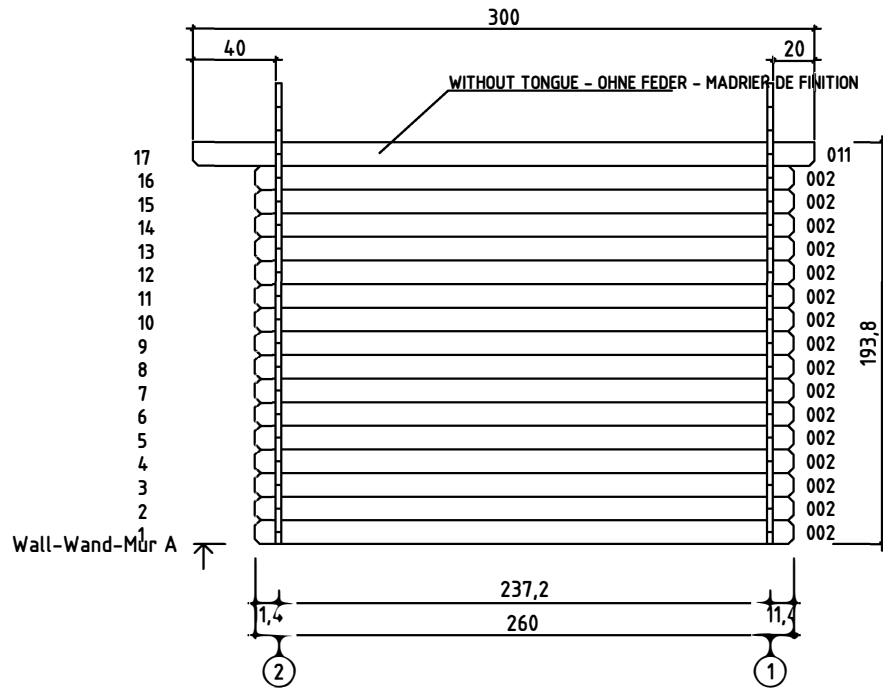
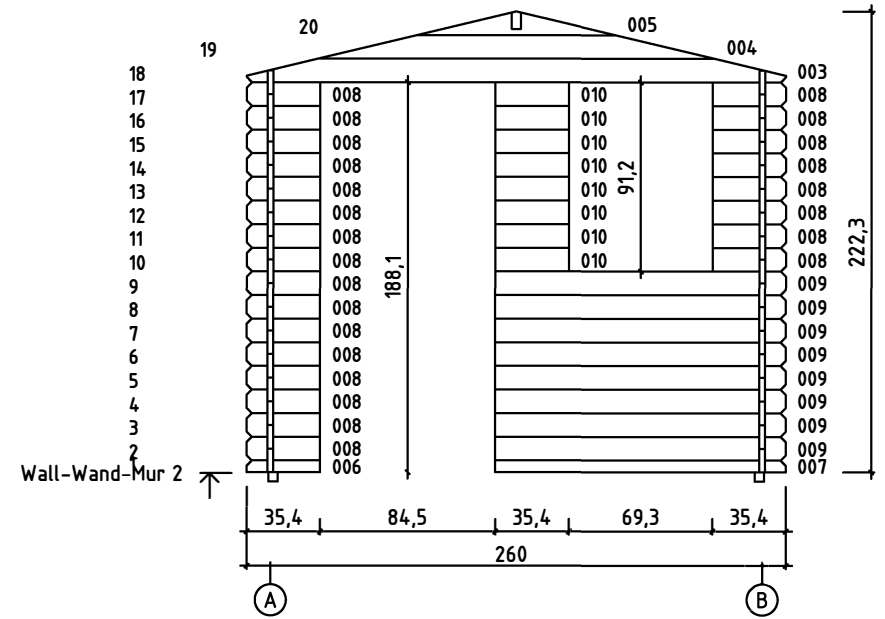
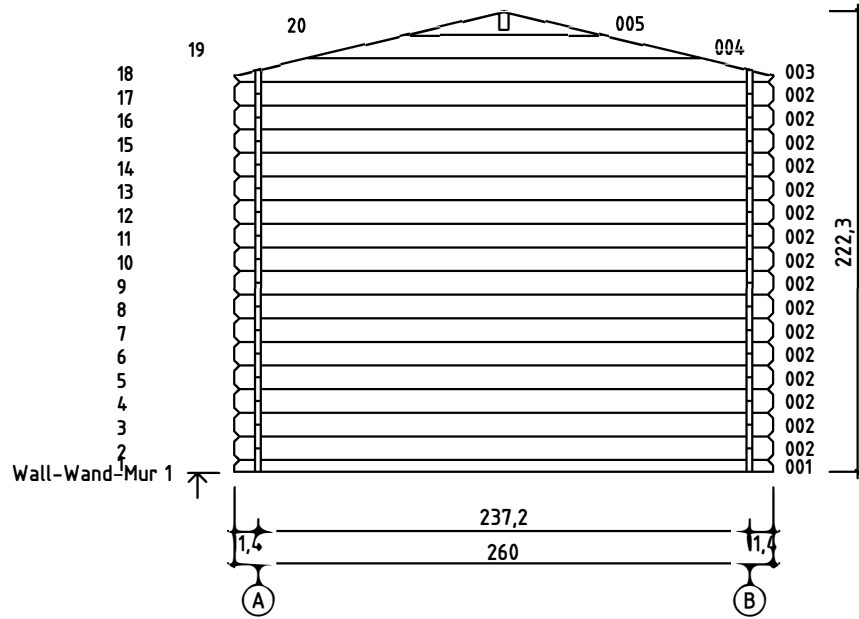

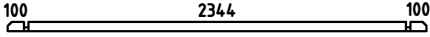
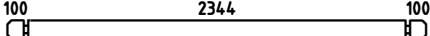

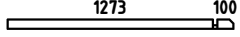

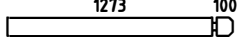

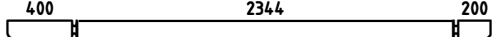
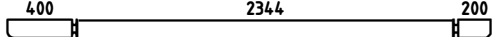
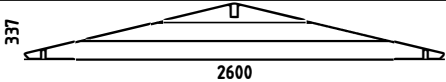
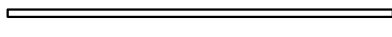
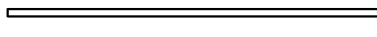
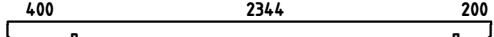
FOUNDATION - FUNDAMENT - FONDATION



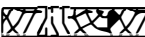

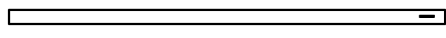
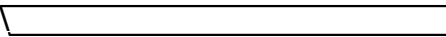

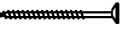





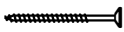

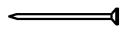
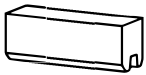
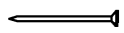
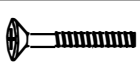
FLOOR BOARDS - FUSSBODENBRETTER - PLAN POSE PLANCHER

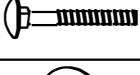

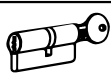

Pos	11.11.2010	4/5	Q.	P (mm)	L (mm)
001			1	28x57	2600
002			48	28x114	2600
006			1	28x57	354
007			1	28x57	1401
008			24	28x114	354
009			8	28x114	1401
010			8	28x114	354
011			1	28x120	3000
012			1	28x120	3000
W1-1 W2-1			1 1		
IAR1		FOUNDATION - FUNDAMENT - FONDATION	2	45x45	2390
IAR2		FOUNDATION - FUNDAMENT - FONDATION	5	45x45	2300
PR11		ROOF BEAM - DACHBALKEN - PANNE DE TOIT	1	44x120	3000
	FLOOR BOARDS - FUSSBODENBRETTER - LAME DE PLANCHER		26	90x18	2340
	ROOF BOARDS - DACHBRETTER - VOLIGES		68	90x18	1500
	FLOOR FILLET-FUSSBODENLEISTE - CORNIERE DE FINITION DU PLANCHER			18x18	9.36
	ROOFING FELT FILLET - DACHPAPPENLEISTE - BAGUETTE DE FIXATION DU FEUTRE BITUMEUX		4	18x58	1550
	EAVES BOARD - TRAUFBRETT - BANDEAU DE TOIT		2	18x90	3000
	ROOF EDGE REINFORCEMENT - DACHRANDVERSTÄRKUNG - CORNIERE DE RENFORT DE BORD DE TOIT		2	28x34	3000
	STORM PROTECTION - STURMLEISTE LATTE ANTI-TEMPETE		4	22x45	1900
	GABLE MOULDING - GIEBELLEISTE PLANCHE DE RIVE		4	18x120	1550
	WINDOW HANDLE FITTINGS-FENSTERGRIFF - POIGNÉE D'OUVERTURE DE FENETRE		1		
	SCREW FOR GABLE SEGMENT - SCHRAUBEN FÜR DECKBLATT - VIS POUR FIXATION LOSANGE DE FINITION		4	3.5x35	
	SCREW FOR DOORSTEP - SCHRAUBEN FÜR SWELLE - VIS DE FIXATION DU SEUIL DE PORTE		2	4.5x65	
	SCREW FOR GABLE MOULDING - SCHRAUBEN FÜR GIEBELLEISTE - VIS DE FIXATION POUR PLANCHE DE RIVE		16	3.5x50	

Pos	11.11.2010	5/5	Q.	P (mm)	L (mm)
	SCREW FOR EAVES BOARDS - SCHRAUBEN FÜR TRAUFBRETTER - VIS DE FIXATION POUR BANDEAU DE TOIT		14	4x40	
	SCREW FOR ROOF EDGE REINFORCEMENT - SCHRAUBEN FÜR DACHRANDVERSTÄRKUNG - VIS POUR RENFORT DE BORD DE TOIT		14	4x40	
	SCREW FOR ROOF BEAMS - SCHRAUBEN FÜR DACHBALKEN - VIS POUR PANNE DE TOIT		6	5x120	
	SCREW FOR 1. WALL BEAM - SCHRAUBE FÜR 1. BOHLENREIHE - VIS DE FIXATION DES FONDATIONS		6	5x90	
	SCREW FOR FUNDAMENT - SCHRAUBEN ZUR BEFESTIGUNG FUNDAMENT - VIS POUR FONDATION		10	5x90	
	ZN NAIL FOR FLOOR FILLET - ZN NÄGEL FÜR FUSSBODENLEISTE - POINTE POUR CORNIERE DE FINITION DU PLANCHER		20	1.4x40	
	HAMMER BLOCK - SCHLAGHOLZ - CALLE DE FRAPPE		1		
	ZN NAIL FOR ROOFING FELT FILLET - ZN NÄGEL FÜR DACHPAPPENLEISTE - POINTE POUR BAGUETTE FIXATION FEUTRE BITUMEUX		16	2x40	
	BOLT FOR WINDOW HANDLE FITTINGS - BOLZEN FÜR FENSTERGRIFF BESCHLAG - BOULON POUR POIGNÉE D'OUVERTURE DE FENETRE		2		
	GABLE SEGMENT-DECKBLATT - LOSANGE DE FINITION		2		
	NUT FOR STORM PROTECTION - SCHRAUBENMUTTER FÜR STURMLEISTE - ÉCROU POUR LAME ANTI-TEMPETE		8		
	BOLT FOR STORM PROTECTION - BOLZEN FÜR STURMLEISTE - VIS POUR LAME ANTI-TEMPETE		8		
	WASHER FOR STORM PROTECTION - DICHTSCHEIBE FÜR STURMLEISTE - RONDELLE POUR LAME ANTI-TEMPETE		8		
	ZN NAIL FOR ROOF - ZN NÄGEL FÜR DACHBRETTER - POINTE POUR TOIT		144	2x50	
	ZN NAIL FOR FLOOR - ZN NÄGEL FÜR FUSSBODENBRETTER - CLOUS POUR PLANCHER		135	2x50	
	SET OF DOOR LOCK COVERS - SCHLOSSBLENDEN - SET DE GARNITURES DE SERRURE DE PORTE		1		
	DOOR HANDLE FITTINGS-TÜRGRIFF - SET DE GARNITURES DE SERRURE DE PORTE		1		
	CYLINDER -ZYLINDERSCHLOSS - CYLINDRE DE SERRURE		1		
	DOOR-TÜR-PORTE 835x1850	UK.2.056.SVV.MMa	1		
	WINDOW-FENSTER-FENETRE 685x882	AK.1.106.SSV.d	1		
	