

Selma
1/9



14.03.2016

VERSION 1

GROUNDPLAN - GRUNDPLAN - PLAN DE MASSE

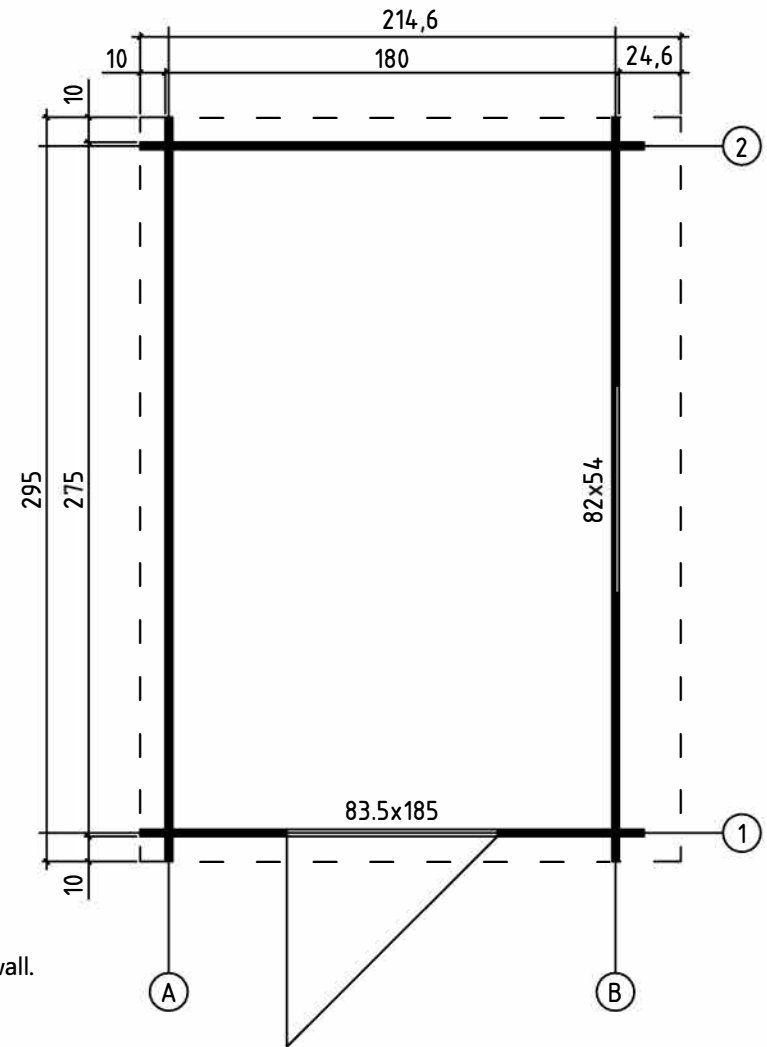
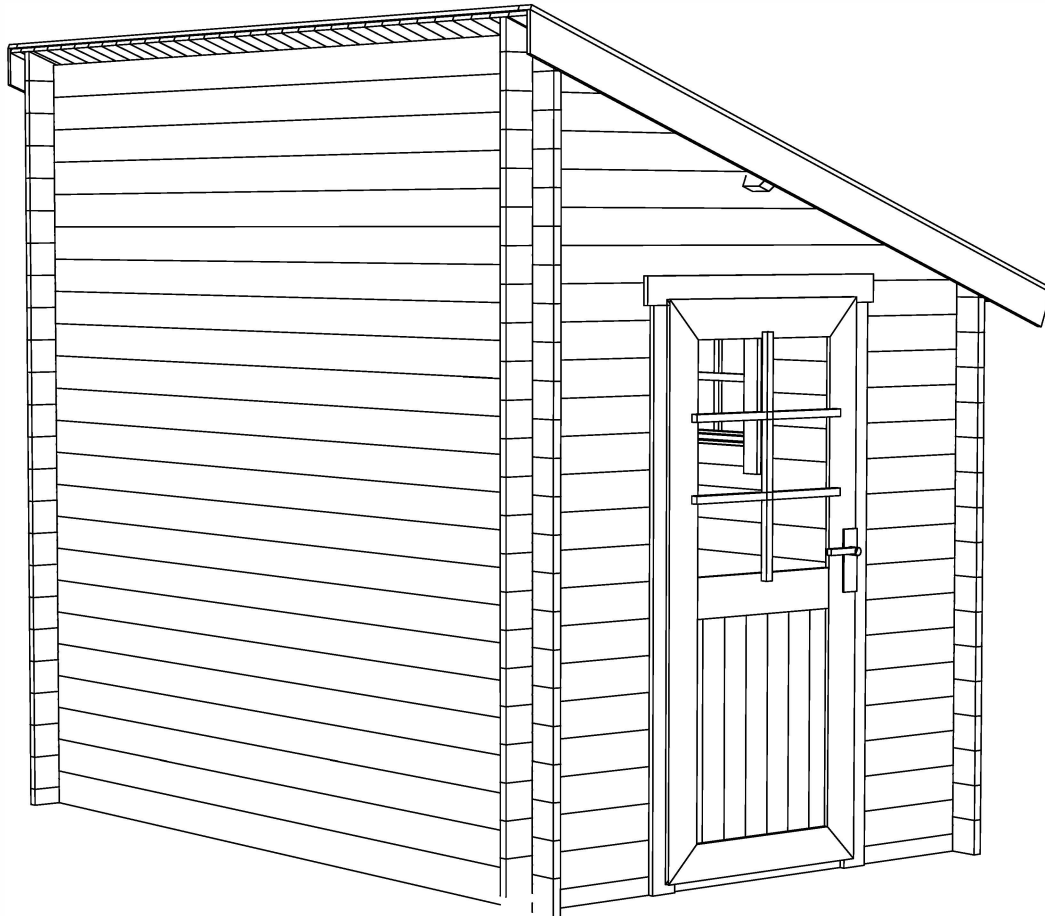

Assembly to the existing wall.

Anbau zu den Wand.

Montage adossé à un mur existant.

VERSION 1

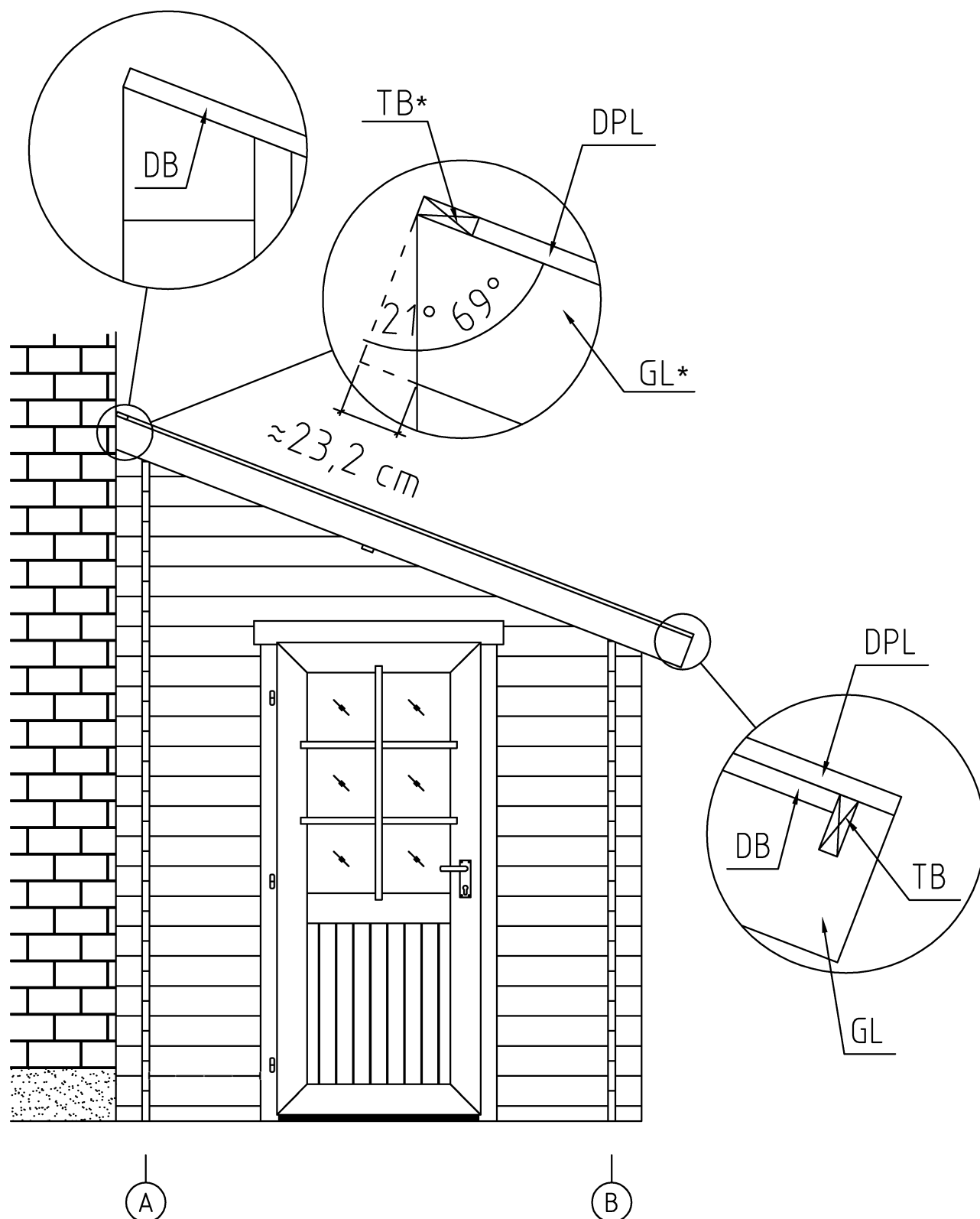

*You have to cut TB and GL to make them fit correctly.
The calculated length of TB is 289 cm.

*TB und GL passend zuschneiden. TB berechnete Länge ist 289 cm.

*Instructions de découpe des détails GL et TB à suivre, pour le côté situé en haut de toiture uniquement :
- Couper l'extrémité de la planche de rive (GL) selon l'angle de coupe indiqué sur le schéma ci-dessus
- Recouper un bandeau de toit (TB) à 289 cm de longueur.

VERSION 2

GROUNDPLAN - GRUNDPLAN - PLAN DE MASSE

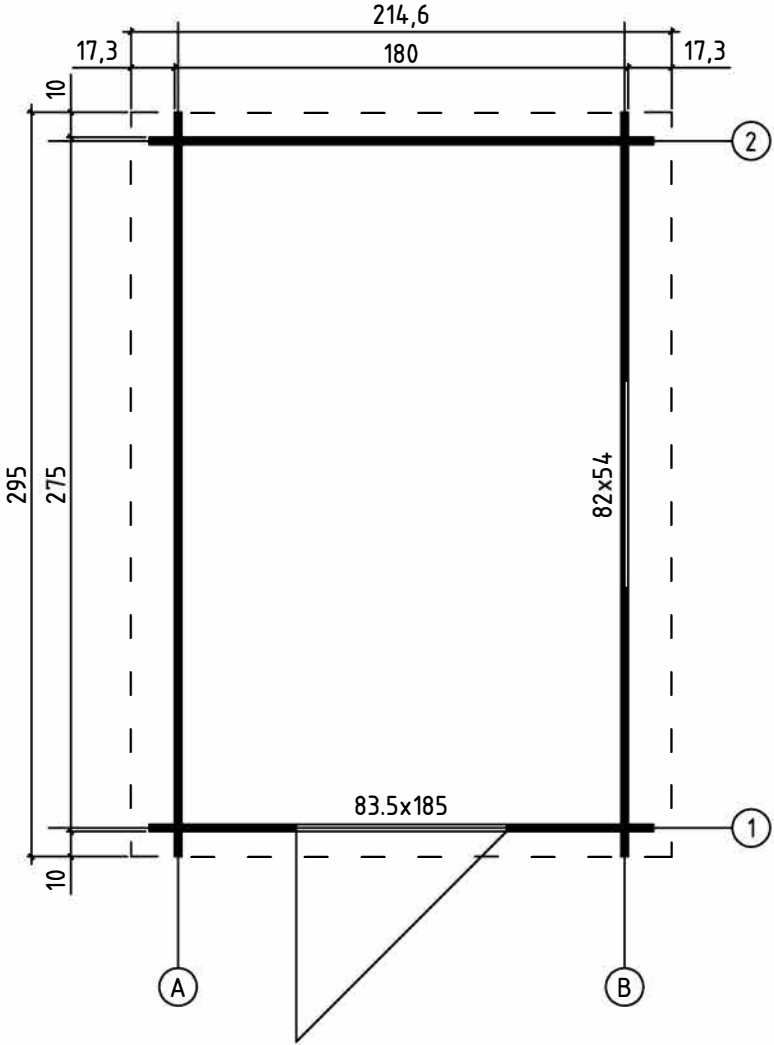
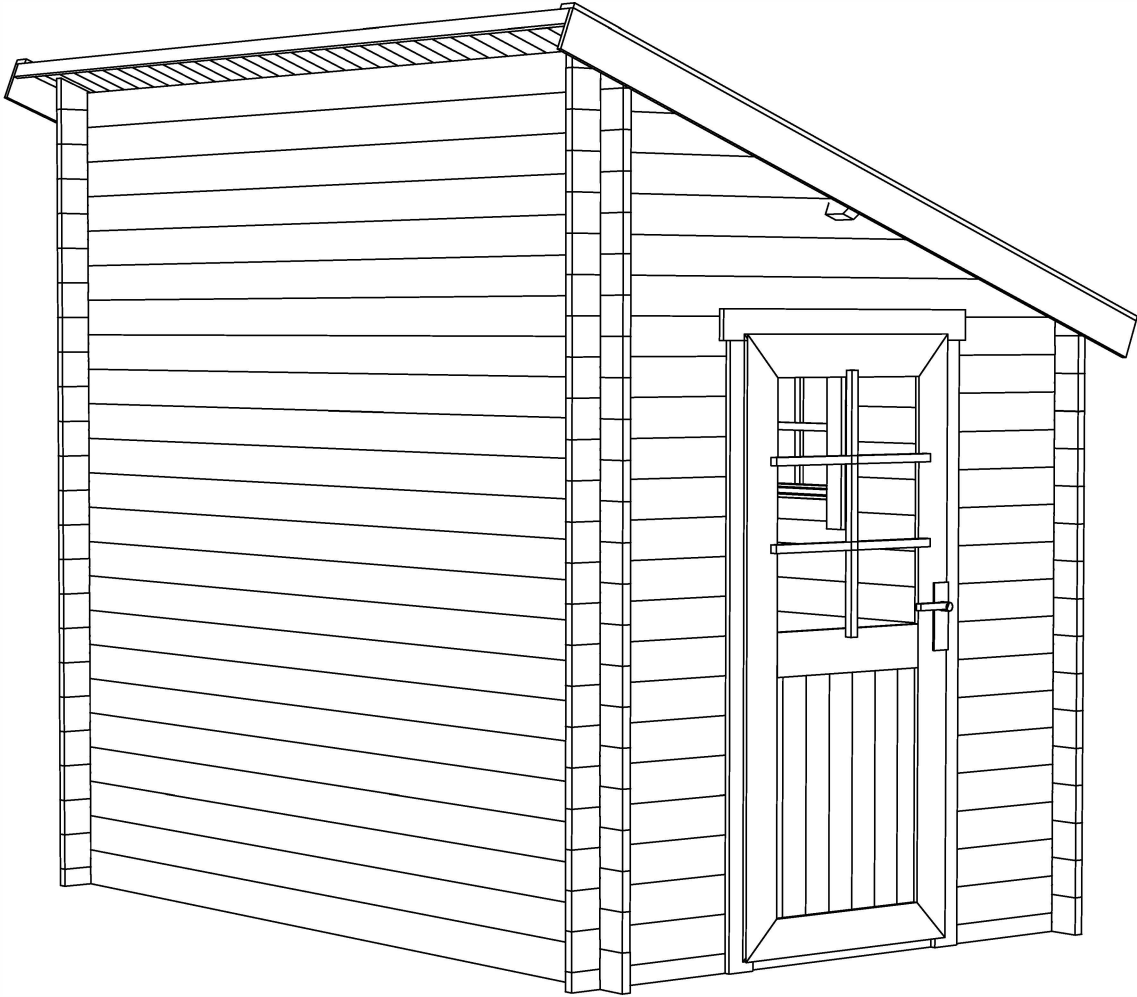

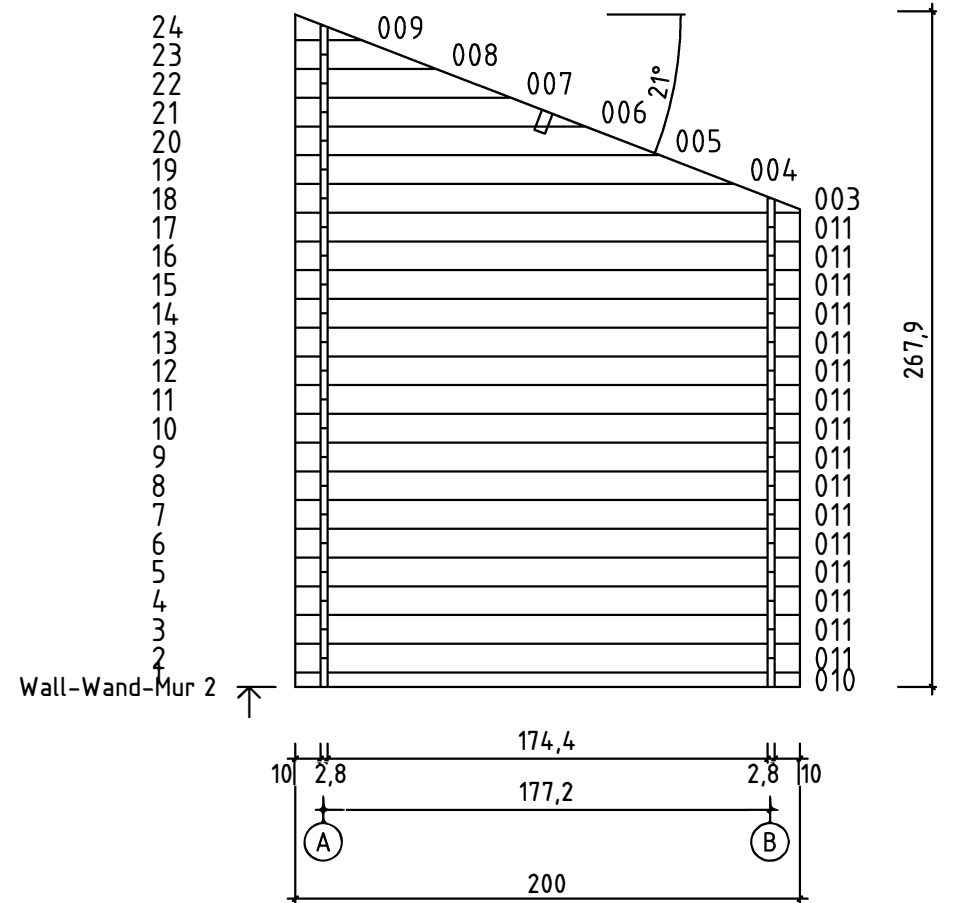
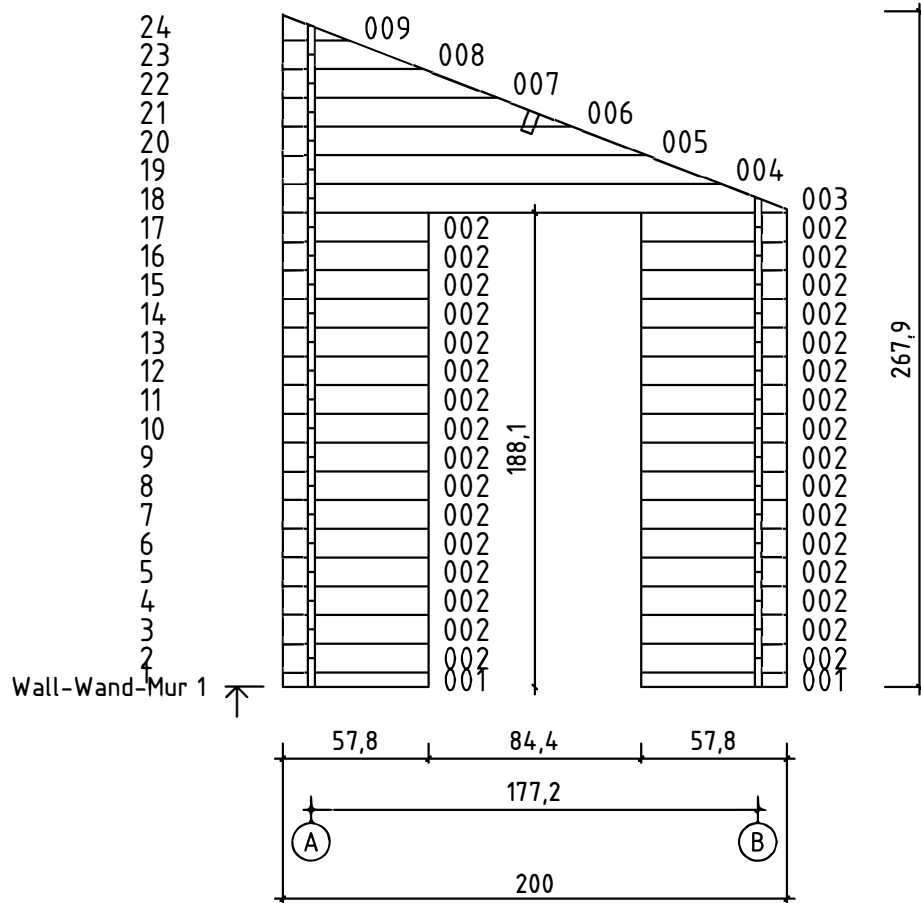

WITHOUT TONGUE - OHNE FEDER - MADRIER DE FINITION

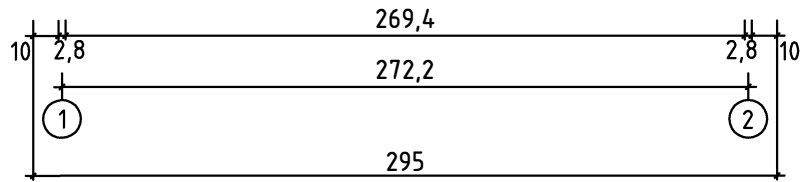
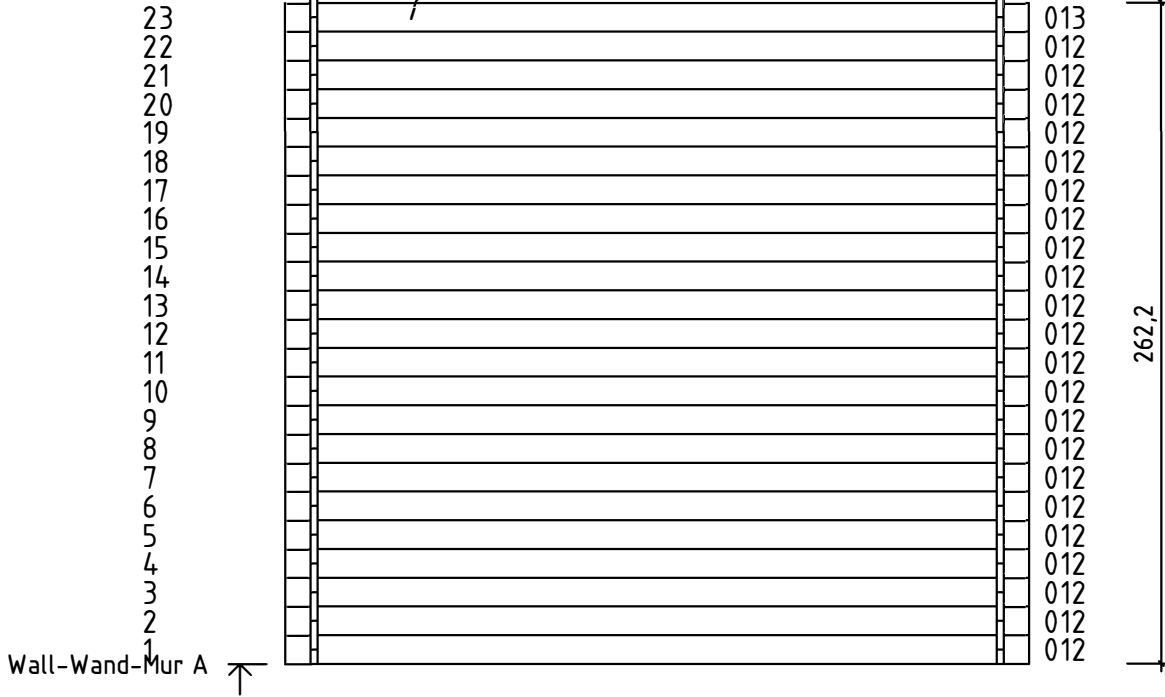

WITHOUT TONGUE - OHNE FEDER - MADRIER DE FINITION

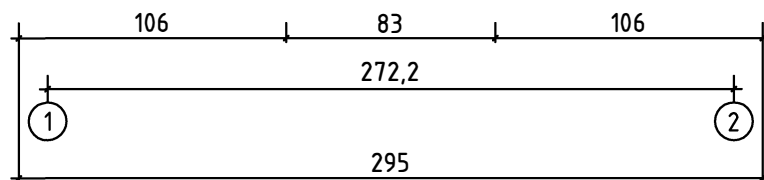
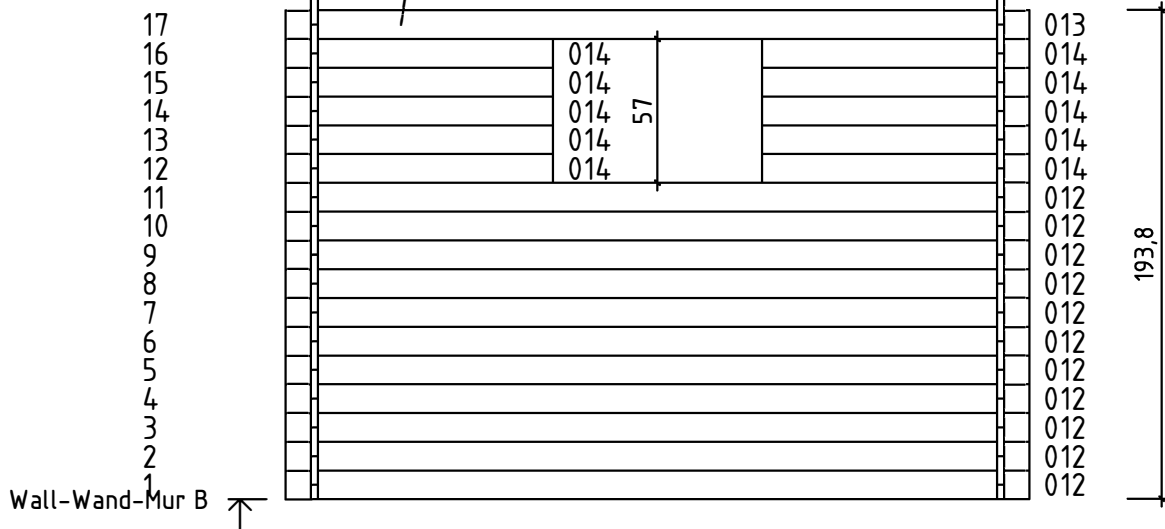

Pos	14.03.2016	Piecelist - Stücklist - Liste des composants	8/9	Q.	P. (mm)	L. (mm)
001				2	28x57	578
002				32	28x114	578
010				1	28x57	2000
011				16	28x114	2000
012				33	28x114	2950
013				2	28x120	2950
014				10	28x114	1060
W1-1 W2-1				1 1		
A-PR1		ROOF BEAM - DACHBALKEN - PANNE DE TOIT		1	44x120	2950
DB	ROOF BOARDS - DACHBRETTER - VOLIGES			33	90x15	2300
DPL	ROOFING FELT FILLET - DACHPAPPENLEISTE - BAGUETTE DE FIXATION DU FEUTRE BITUMEUX			2	15x45	2350
TB	FASCIA BOARD - TRAUFBRETT - BANDEAU DE TOIT			2	15x45	2950
KFS-1	STORM PROTECTION - STURMLEISTE - - LATTE ANTI-TEMPETE			2	22x45	2050
KFS-2	STORM PROTECTION - STURMLEISTE - - LATTE ANTI-TEMPETE			2	22x45	2500
GL	GABLE MOULDING - GIEBELLEISTE - - PLANCHE DE RIVE			2	15x120	2350
	SCREW FOR GEORGIAN BARS - SCHRAUBE FÜR SPROSSEN - VIS DE BARRES GEORGIANNE			6	2.5x20	
	SCREW FOR GEORGIAN BARS - SCHRAUBE FÜR SPROSSEN - VIS DE BARRES GEORGIANNE			6	2.5x20	
HS16	SCREW FOR GABLE MOULDING - SCHRAUBEN FÜR GIEBELLEISTE - VIS POUR FIXATION PLANCHE DE RIVE			12	3.5x50	
HS32	SCREW FOR FASCIA BOARDS - SCHRAUBEN FÜR TRAUFBRETTER - VIS POUR FIXATION BANDEAU DE TOIT			14	4x40	
HS43	SCREW FOR ROOF BEAMS - SCHRAUBEN FÜR DACHBALKEN - VIS POUR FIXATION PANNES DE TOIT			6	5x120	
	SCREW FOR GABLE - SCHRAUBEN FÜR GIEBEL - VIS POUR FIXATION DES PIGNONS			28	5x120	
HS59	SCREW FOR DOORSTEP - SCHRAUBEN FÜR SWELLE - VIS POUR FIXATION BARRE DE SEUIL			2	4.5x65	
SH28	HAMMER BLOCK - SCHLAGHOLZ - CALLE DE FRAPPE			1		
SFS	NUT FOR STORM PROTECTION - SCHRAUBENMUTTER FÜR STURMLEISTE - ECROU POUR LATTE ANTI-TEMPETE			8	D6	

