

*Lilly*  
1/7

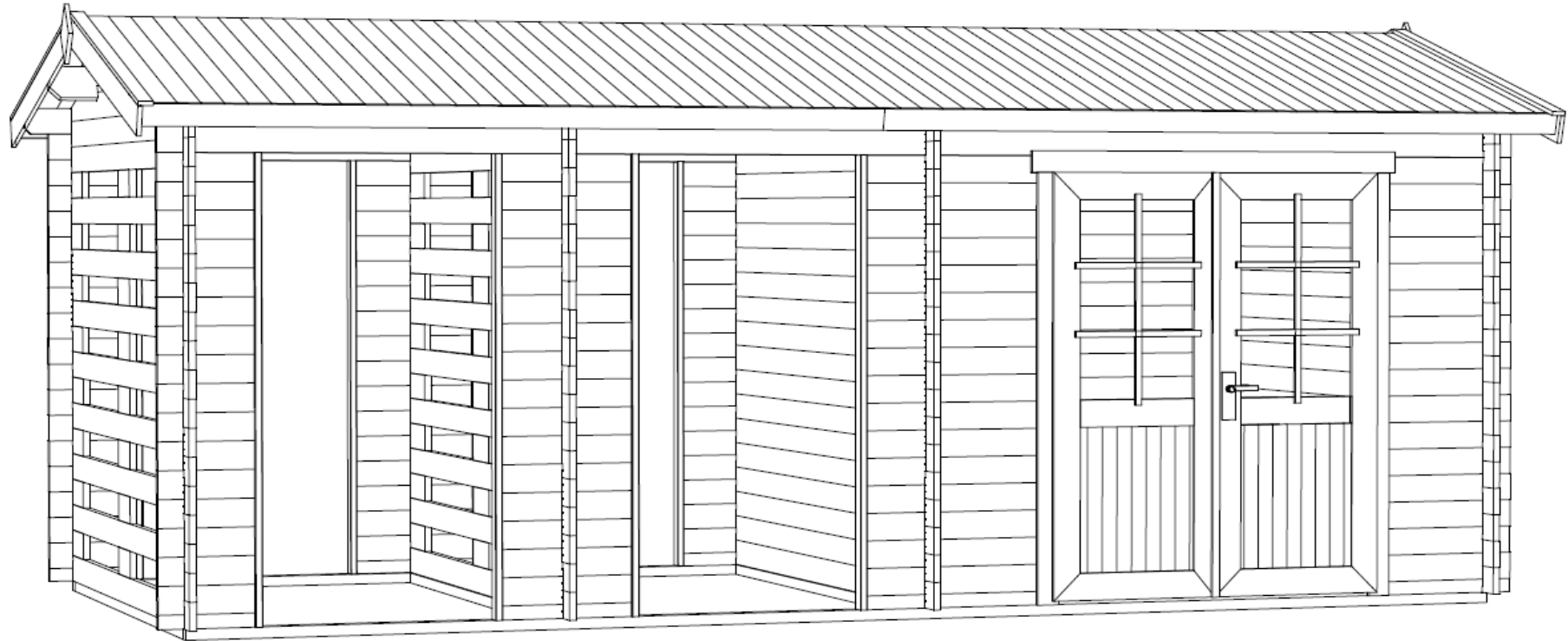

2.11.2015

GROUNDPLAN - GRUNDPLAN - PLAN DE MASSE

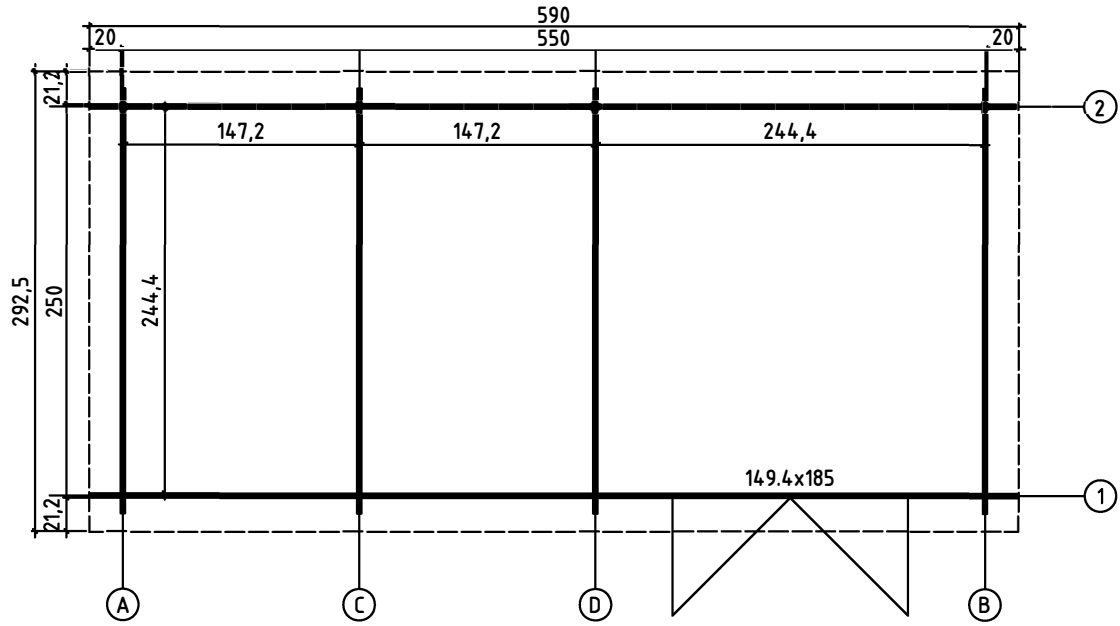

FOUNDATION - FUNDAMENT - FONDATION

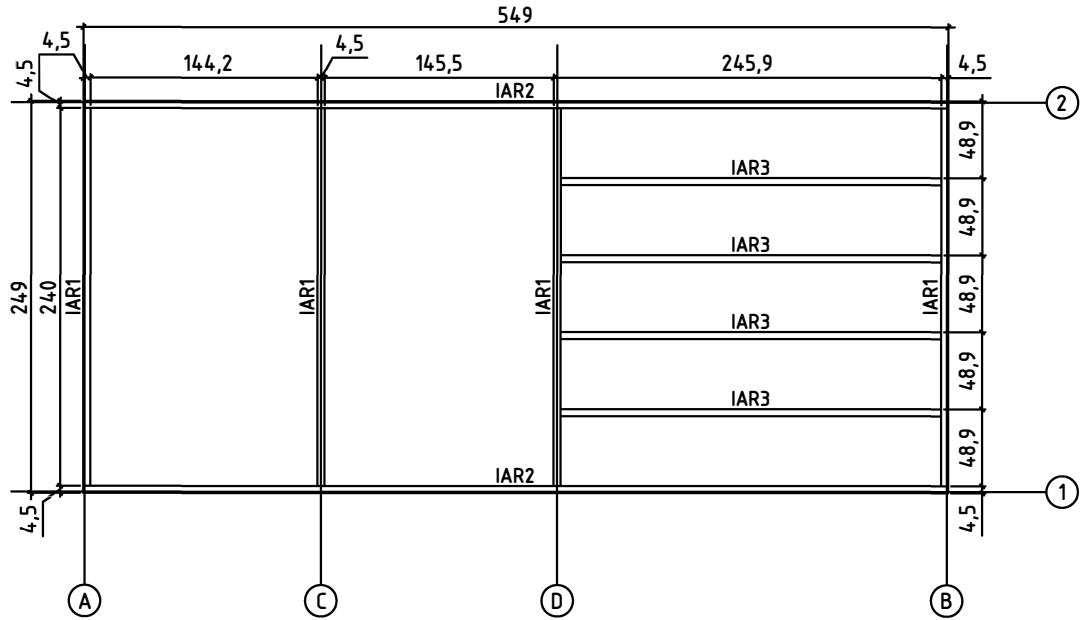



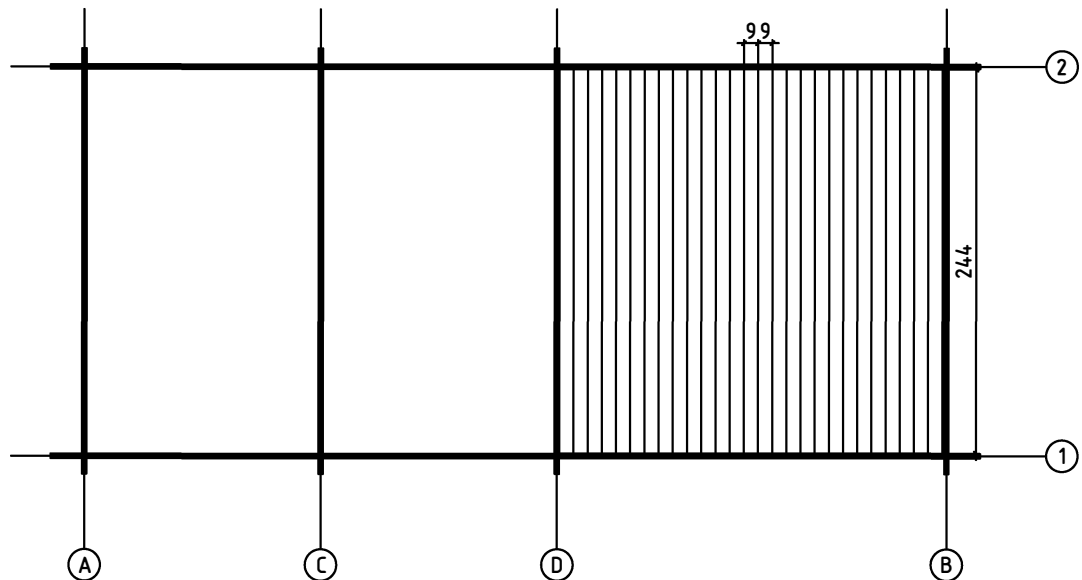

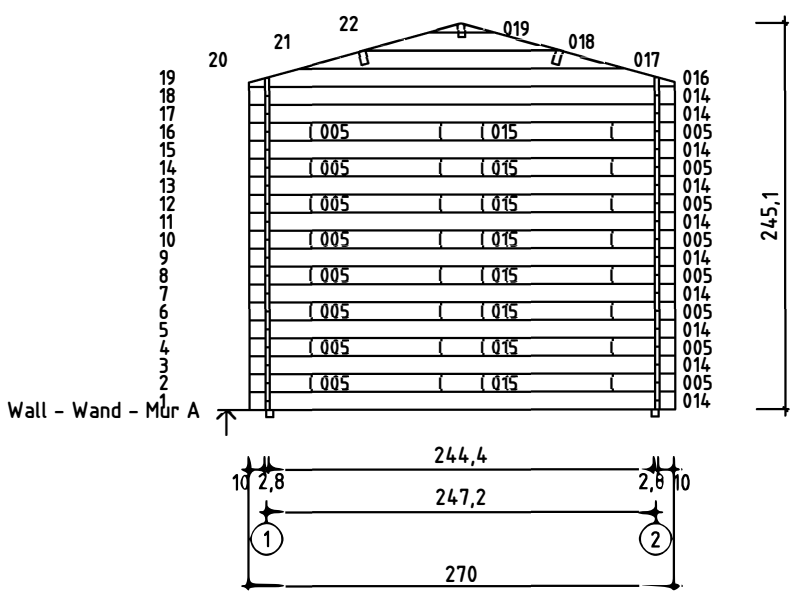
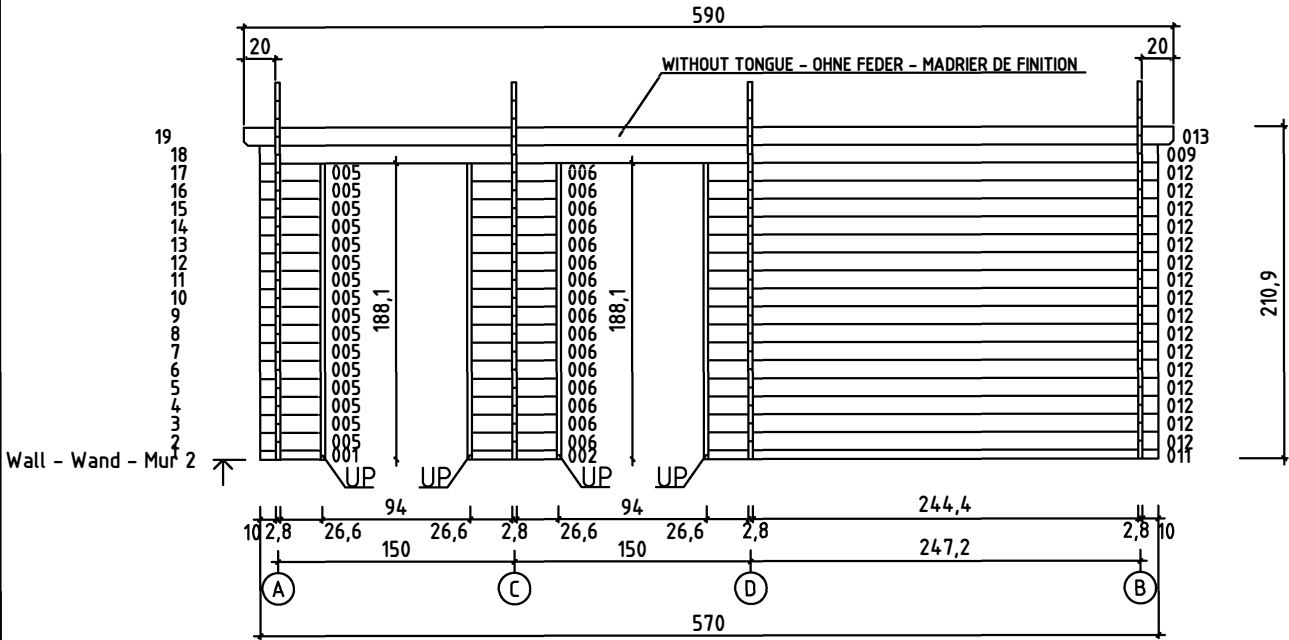
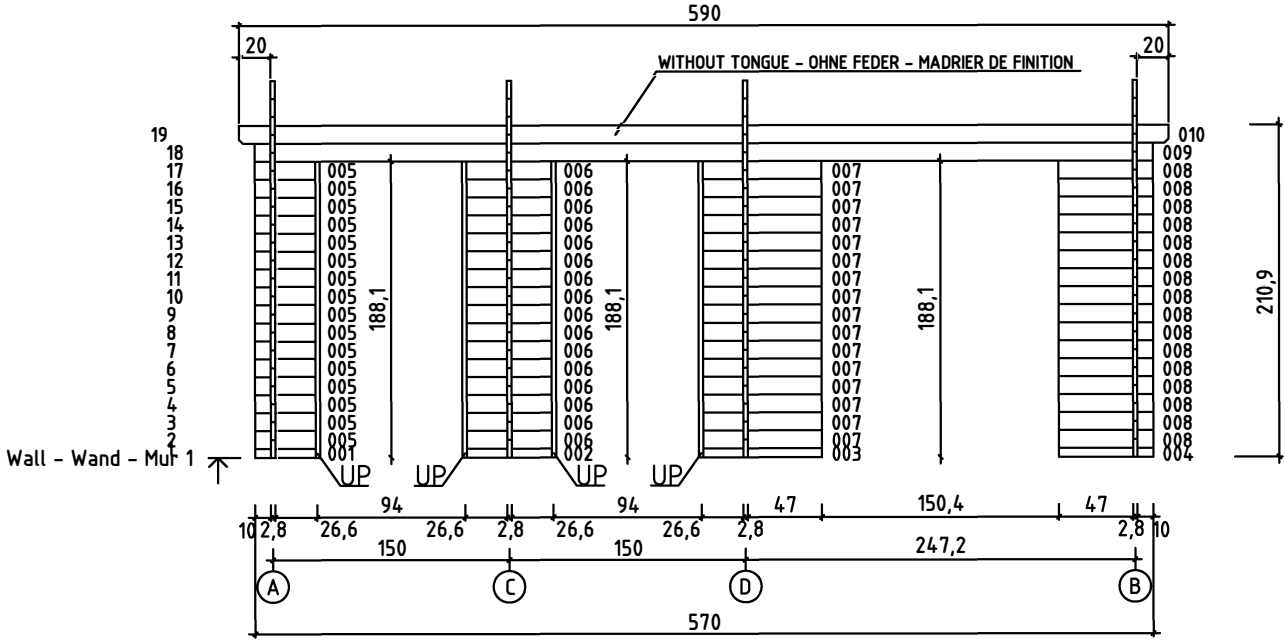

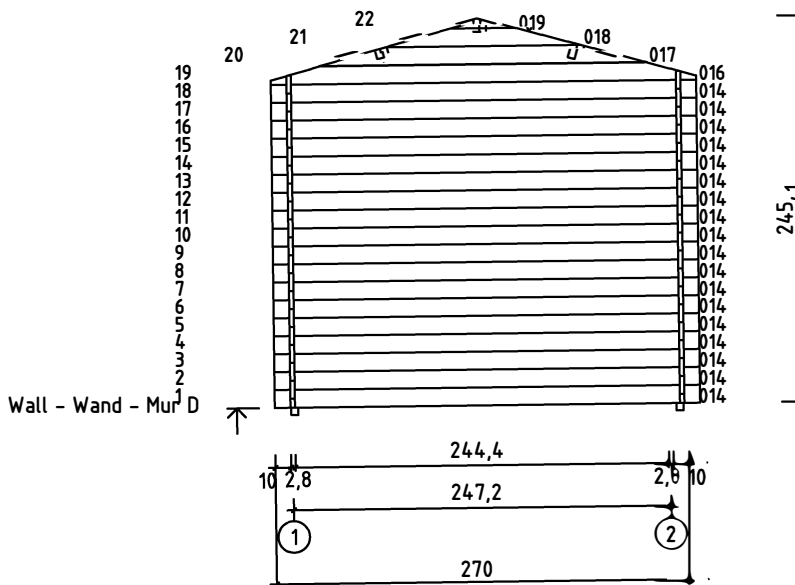
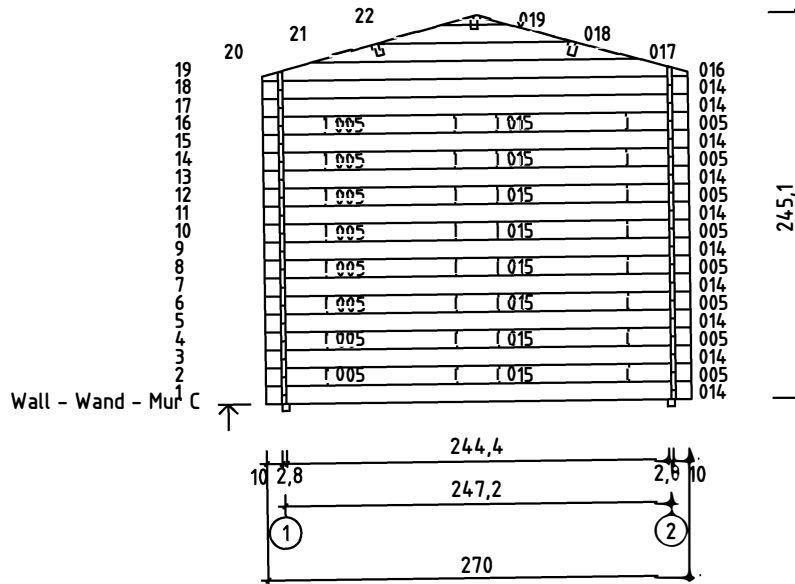
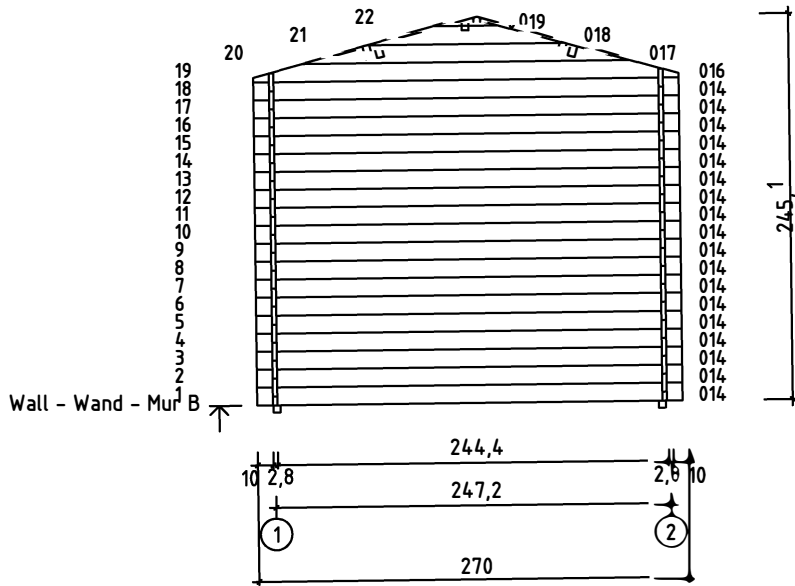





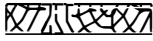

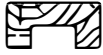
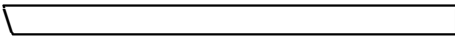

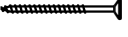

FLOOR BOARDS - FUSSBODENBRETTER - PLAN POSE PLANCHER





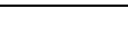

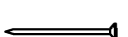

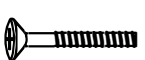

Pos	02.11.2015	Piece list - Stückliste - Liste des pièces	5/7	Q.	P (mm)	L (mm)
001				2	28x57	394
002				2	28x57	560
003				1	28x57	764
004				1	28x57	598
005				64	28x114	394
006				32	28x114	560
007				16	28x114	764
008				16	28x114	598
009				2	28x114	5700
010				1	28x120	5900
011				1	28x57	2866
012				16	28x114	2866
013				1	28x120	5900
014				56	28x114	2700
015				16	28x114	267
WA-1				1		
WB-1				1		
WC-1				1		
WD-1				1		
IAR2		FOUNDATION - FUNDAMENT - FONDATION		2	45x45	5490
IAR3		FOUNDATION - FUNDAMENT - FONDATION		4	45x45	2414
IAR1		FOUNDATION - FUNDAMENT - FONDATION		4	45x45	2400
PR1		ROOF BEAM - DACHBALKEN - PANNE DE TOIT		1	44x140	5900
A-PR1		ROOF BEAM - DACHBALKEN - PANNE DE TOIT		2	44x140	5900
		FLOOR BOARDS - FUSSBODENBRETTER - LAME DE PLANCHER		28	90x18	2440

Pos	02.11.2015	Piece list - Stückliste - Liste des pièces	6/7	Q.	P (mm)	L (mm)
		ROOF BOARDS - DACHBRETTER - VOLIGES		132	90x18	1500
		FLOOR FILLET - FUSSBODENLEISTE - CORNIERE DE FINITION DU PLANCHER			18x18	9.76
		ROOFING FELT FILLET - DACHPAPPENLEISTE - BAGUETTE DE FIXATION DU FEUTRE BITUMEUX		4	18x58	1550
		FASCIA BOARD - TRAUFBRETT - BANDEAU DE TOIT		4	18x90	2950
		ROOF EDGE REINFORCEMENT - DACHRANDVERSTÄRKUNG - CORNIERE DE RENFORT DE BORD DE TOIT		4	28x34	2950
		STORM PROTECTION - STURMLEISTE - LATTE ANTI-TEMPETE		4	22x45	2050
UP		U-PROFILE - U-PROFIL - PROFILE U		8	28x58	1880
		GABLE MOULDING - GIEBELLEISTE - PLANCHE DE RIVE		4	18x120	1550
		SCREW FOR GEORGIAN BARS - SCHRAUBE FÜR SPROSSEN - VIS DE BARRES GEORGIENNE		12	2.5x20	
		SCREW FOR GABLE SEGMENT - SCHRAUBEN FÜR DECKBLATT - VIS POUR FIXATION LOSANGE DE FINITION		4	3.5x35	
		SCREW FOR GABLE MOULDING - SCHRAUBEN FÜR GIEBELLEISTE - VIS DE FIXATION POUR PLANCHE DE RIVE		24	3.5x50	
		SCREW FOR DOOR FILLET - SCHRAUBE ZUR BEFESTIGUNG TÜRLEISTE - VIS D'ASSEMBLAGE DU CADRE DE PORTE		5	3x30	
		SCREW FOR U-PROFILE - SCHRAUBE ZUR BEFESTIGUNG U-PROFILS - VIS A TETE FRAISÉE POUR PROFIL U		48	4.5x80	
		SCREW FOR FASCIA BOARDS - SCHRAUBEN FÜR TRAUFBRETTER - VIS DE FIXATION POUR BANDEAU DE TOIT		28	4x40	
		SCREW FOR ROOF EDGE REINFORCEMENT - SCHRAUBEN FÜR DACHRANDVERSTÄRKUNG - VIS POUR RENFORT DE BORD DE TOIT		28	4x40	
		SCREW FOR ROOF BEAMS - SCHRAUBEN FÜR DACHBALKEN - VIS POUR PANNE DE TOIT		20	5x120	
		SCREW FOR 1. WALL BEAM - SCHRAUBE FÜR 1. BOHLENREIHE - VIS DE FIXATIONS 1ÈRE RANGÉE DE MADRIERS AVEC POUTRELLES DE FONDATIONS		14	5x90	
		SCREW FOR FOUNDATION - SCHRAUBEN ZUR BEFESTIGUNG FUNDAMENT - VIS DE FIXATIONS DES POUTRELLES DE FONDATIONS		16	5x90	
		SCREW FOR DOOR JAMB - SCHRAUBE FÜR TÜRRAHMEN - VIS DE FIXATION POUR MONTANT DE PORTE		4	5x90	
		ZN NAIL FOR FLOOR FILLET - ZN NÄGEL FÜR FUSSBODENLEISTE - POINTE POUR CORNIERE DE FINITION DU PLANCHER		21	1.4x40	
		HAMMER BLOCK - SCHLAGHOLZ - CALLE DE FRAPPE		1		
		NUT FOR STORM PROTECTION - SCHRAUBENMUTTER FÜR STURMLEISTE - ÉCROU POUR LAME ANTI-TEMPETE		8		
		ZN NAIL FOR ROOF - ZN NÄGEL FÜR DACHBRETTER - POINTES DE FIXATIONS DES VOLIGES DE TOIT		410	2x50	
		ZN NAIL FOR FLOOR - ZN NÄGEL FÜR FUSSBODENBRETTER - CLOUS POUR PLANCHER		174	2x50	
		BOLT FOR STORM PROTECTION - BOLZEN FÜR STURMLEISTE - VIS POUR LAME ANTI-TEMPETE		8		

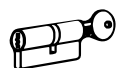
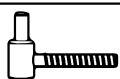
Pos	02.11.2015	Piece list - Stückliste - Liste des pièces	7/7	Q.	P (mm)	L (mm)
		GABLE SEGMENT - DECKBLATT - LOSANGE DE FINITION		2		
		WASHER FOR STORM PROTECTION - DICHTSCHEIBE FÜR STURMLEISTE - RONDELLE POUR LAME ANTI-TEMPETE		8		
		DOOR HANDLE FITTINGS - TÜRGRIF - SET DE GARNITURES DE SERRURE DE PORTE		1		
		SET OF DOOR LOCK COVERS - SCHLOSSBLENDEN - SET DE GARNITURES DE SERRURE DE PORTE		1		
		CYLINDER LOCK - ZYLINDERSCHLOSS - CYLINDRE DE SERRURE		1	30x35	
		MALE BOLT HINGE FOR DOOR - TÜRRIEGEL - PARTIE MALE DE CHARNIERE DE PORTE		6		
		DOOR - TÜR - PORTE 1494x1850	TUK.2.056.SVP.MMc	SGC	1	
