

*Felicia A*

1/8

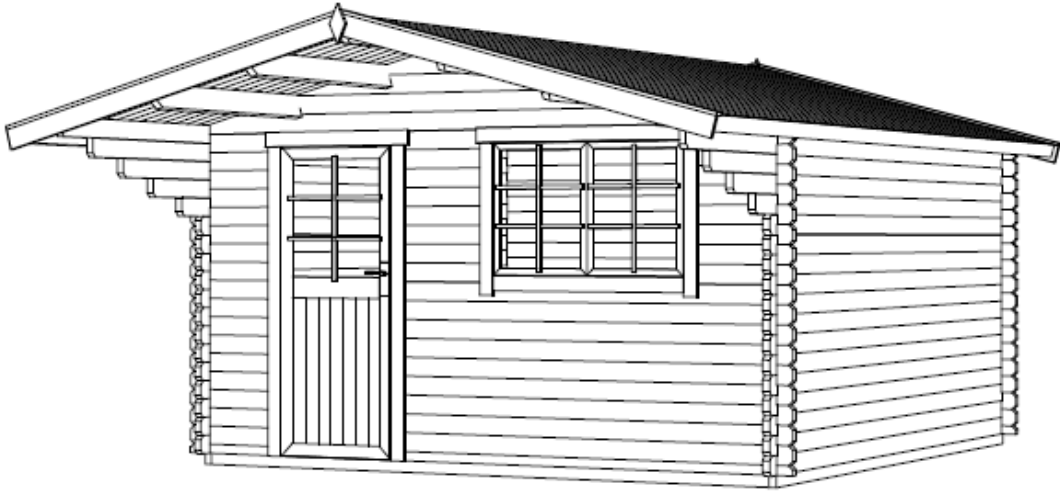

GROUNDPLAN - GRUNDPLAN - PLAN DE MASSE

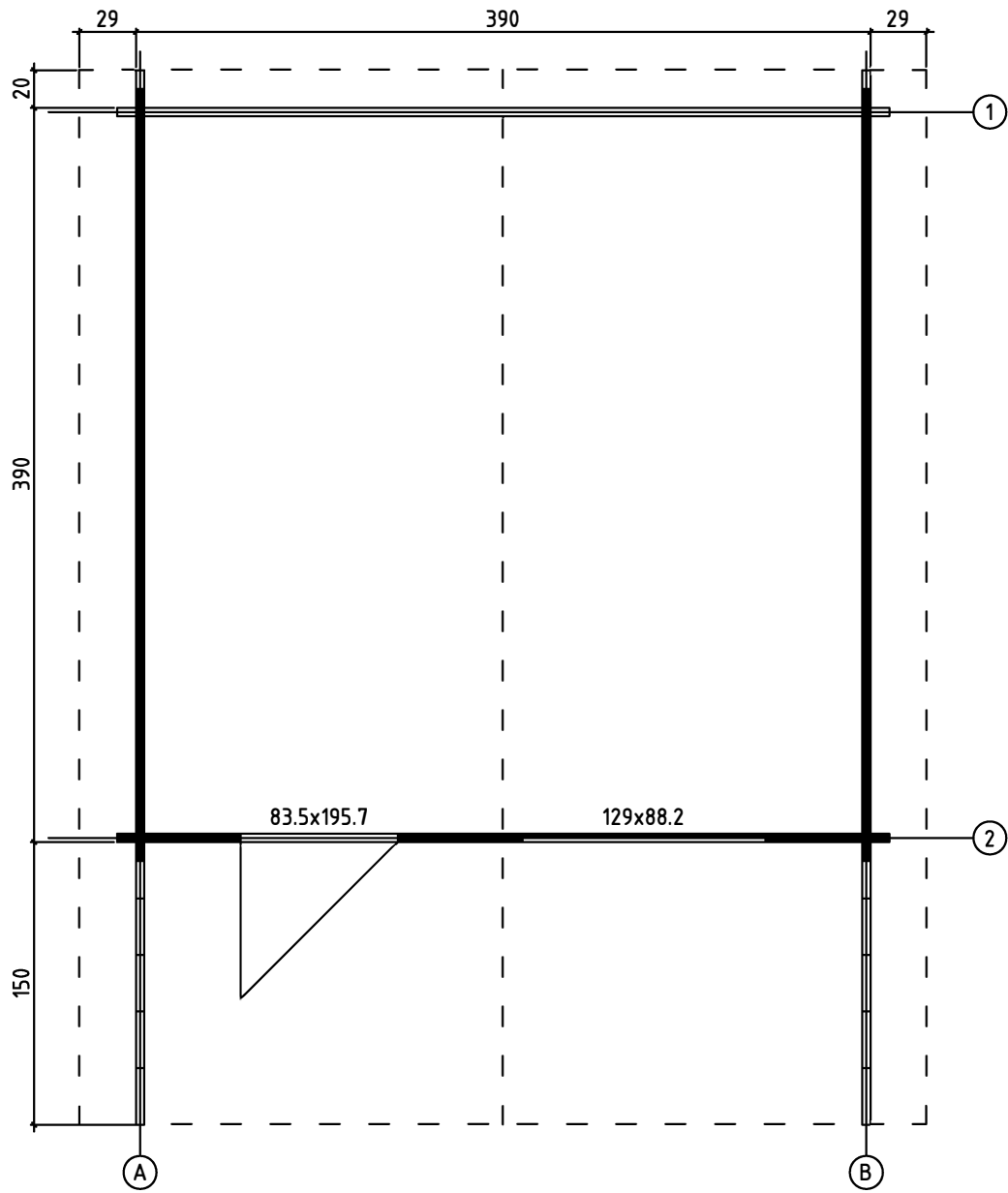

FOUNDATION - FUNDAMENT - FONDAATION

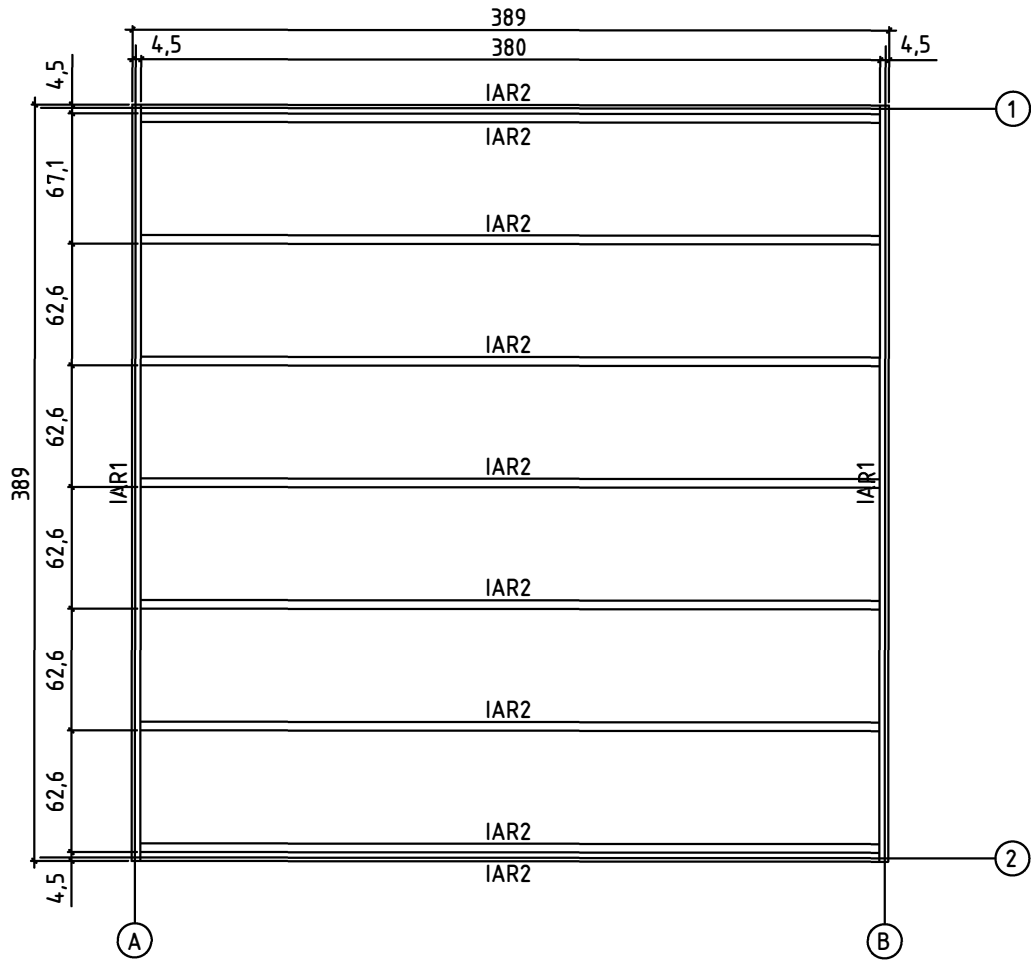



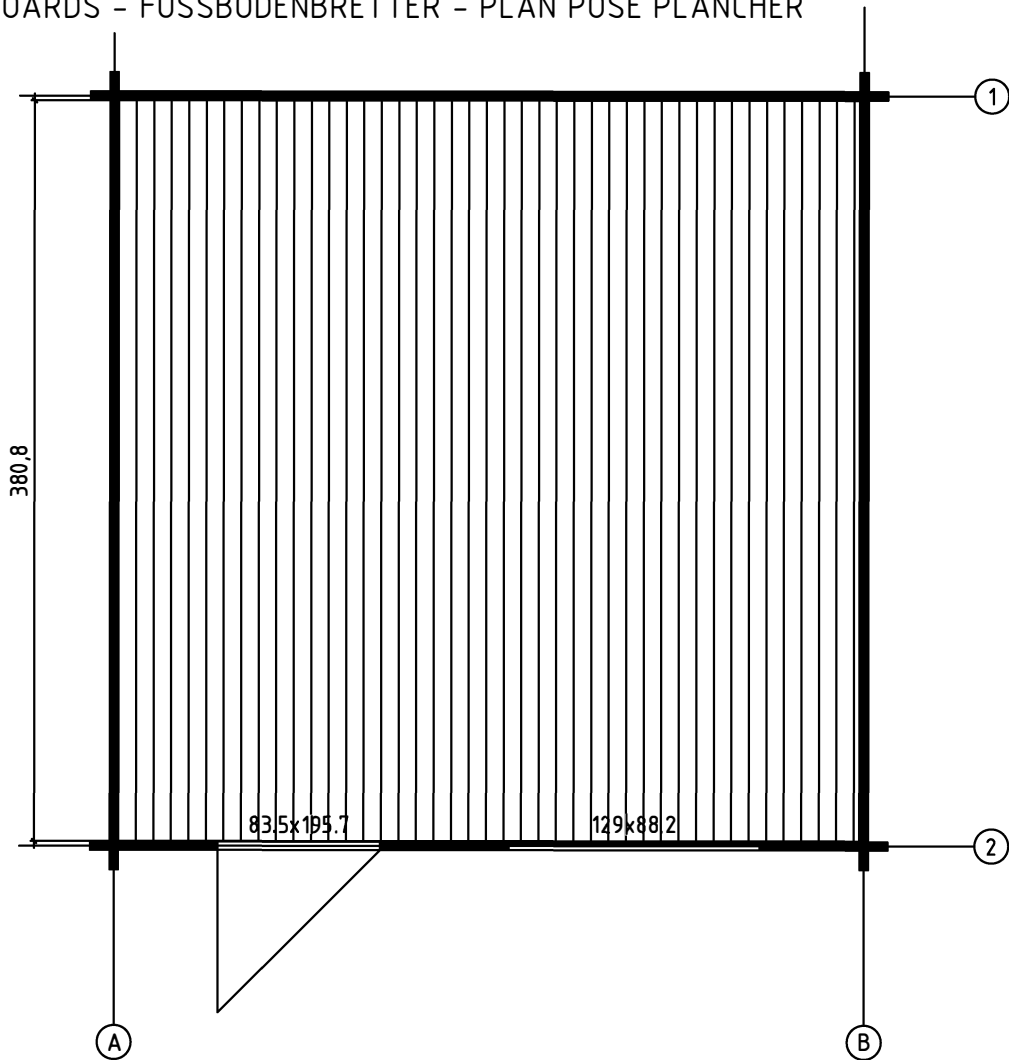

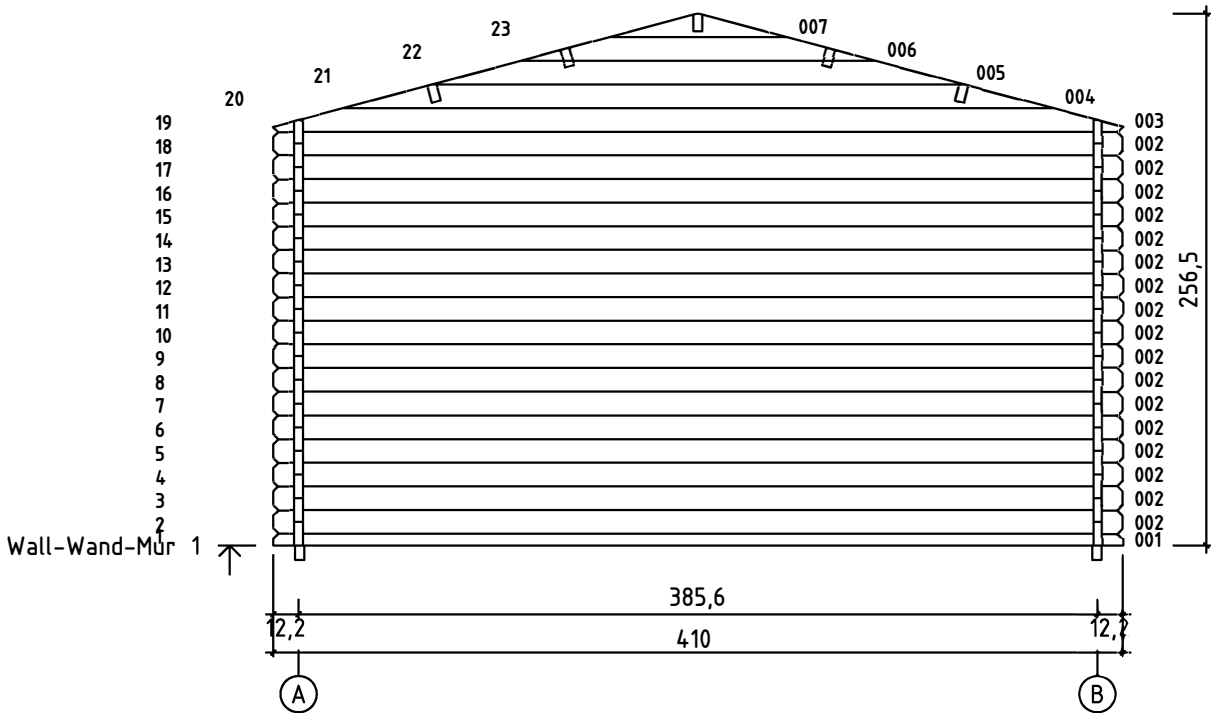
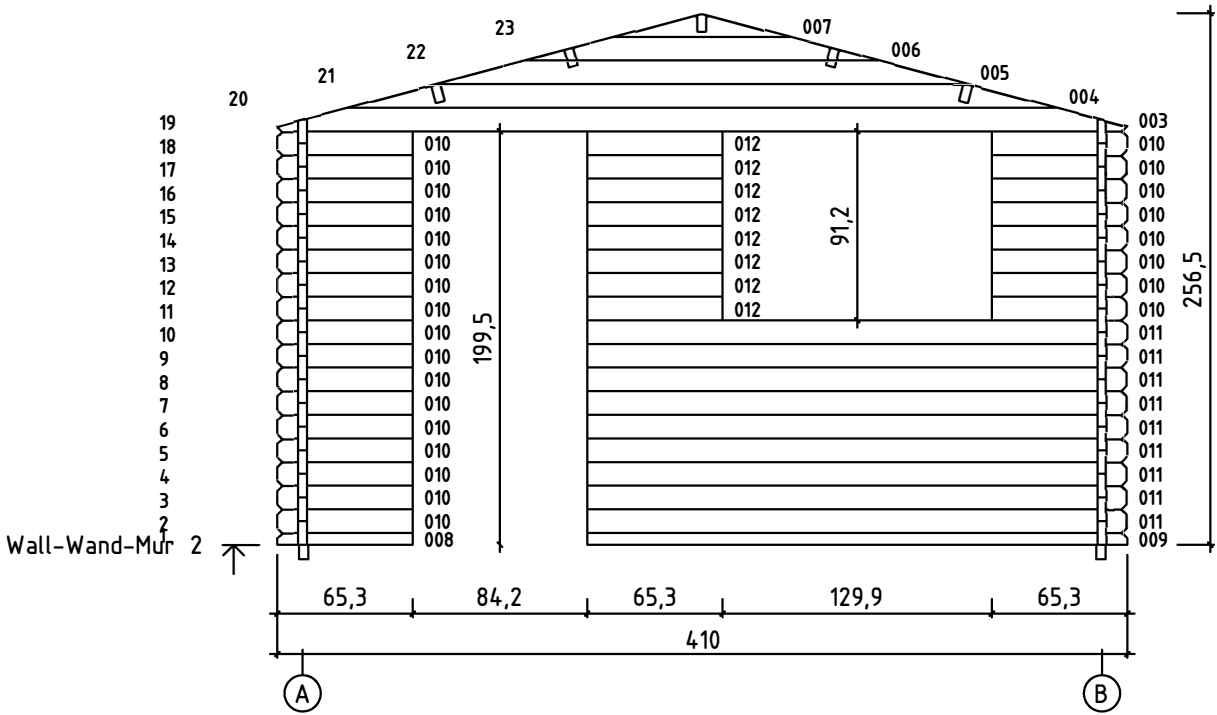

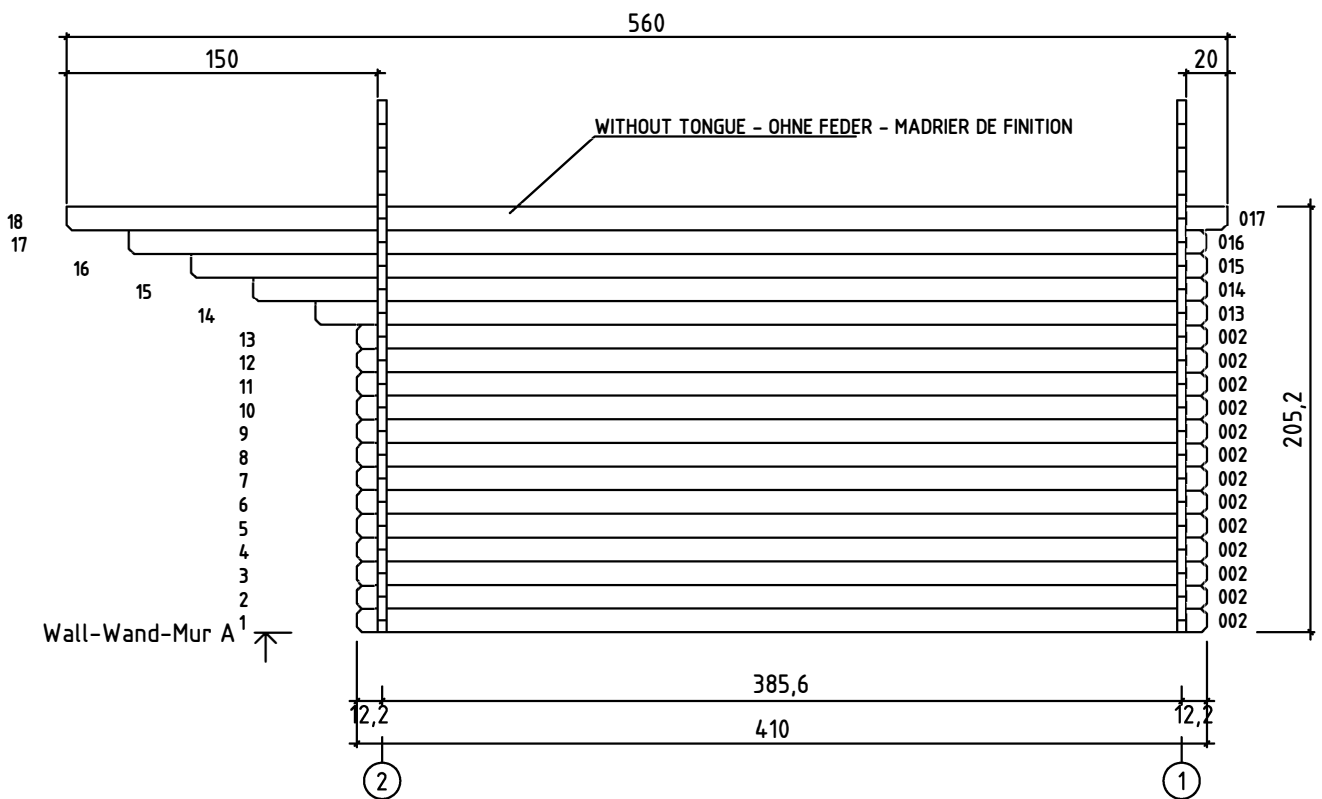
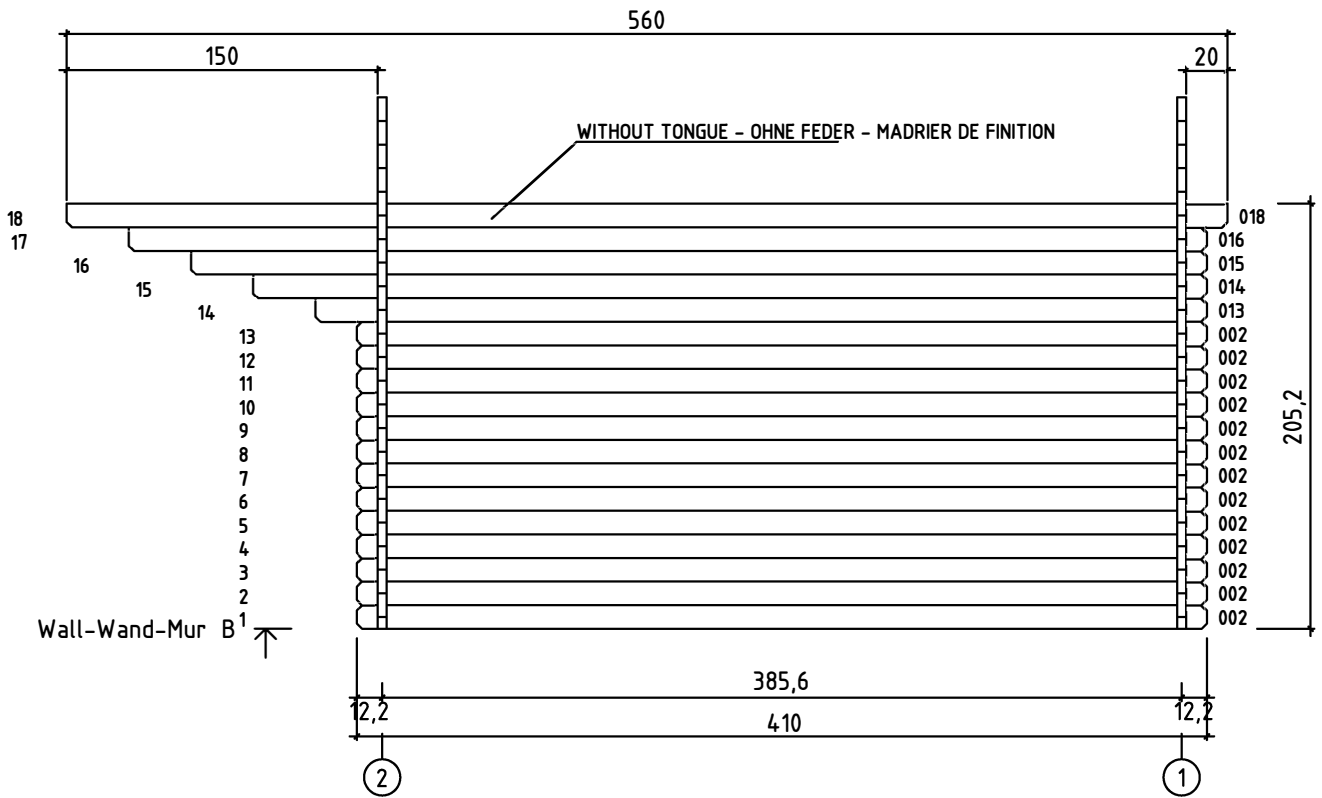

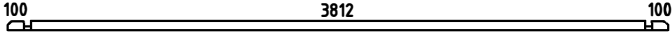
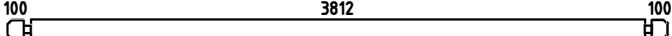
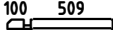
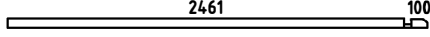
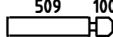
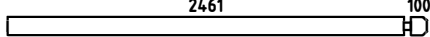
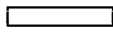
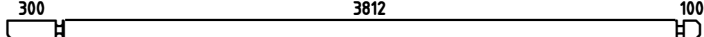
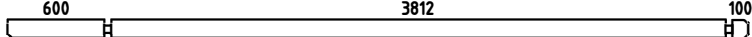
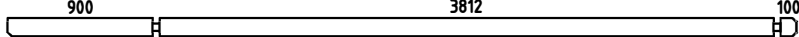
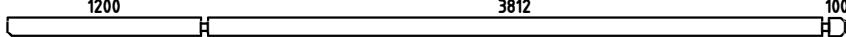
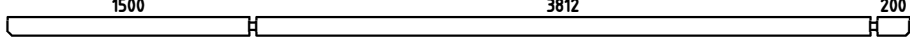
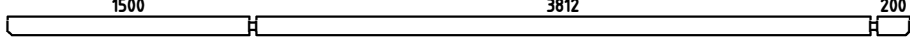
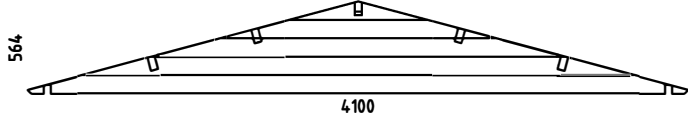
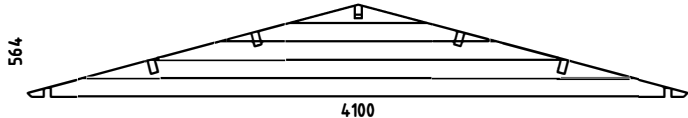
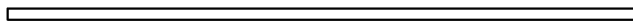
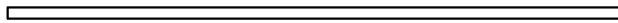
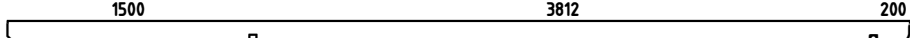
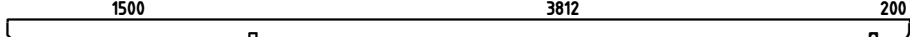



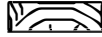

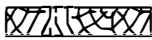

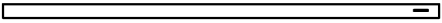
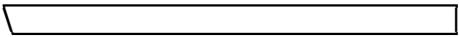

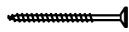

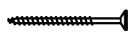
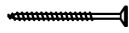
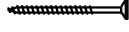
FLOOR BOARDS - FUSSBODENBRETTER - PLAN POSE PLANCHER

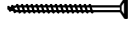
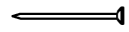

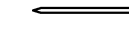
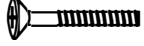

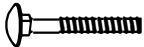

| Pos  | 04.01.2011  | 6/8 | St. | Profile (mm) | Lenght (mm) |
|------|---|-----|-----|--------------|-------------|
| 001  |    |     | 1   | 44x57        | 4100        |
| 002  |    |     | 43  | 44x114       | 4100        |
| 008  |    |     | 1   | 44x57        | 653         |
| 009  |    |     | 1   | 44x57        | 2605        |
| 010  |    |     | 25  | 44x114       | 653         |
| 011  |    |     | 9   | 44x114       | 2605        |
| 012  |    |     | 8   | 44x114       | 653         |
| 013  |    |     | 2   | 44x114       | 4300        |
| 014  |    |     | 2   | 44x114       | 4600        |
| 015  |   |     | 2   | 44x114       | 4900        |
| 016  |    |     | 2   | 44x114       | 5200        |
| 017  |   |     | 1   | 44x120       | 5600        |
| 018  |   |     | 1   | 44x120       | 5600        |
| W1-1 |   |     | 1   |              |             |
| W2-1 |   |     | 1   |              |             |
| IAR1 | FOUNDATION - FUNDAMENT - FONDATION<br>   |     | 2   | 45x70        | 3890        |
| IAR2 | FOUNDATION - FUNDAMENT - FONDATION<br>   |     | 9   | 45x70        | 3800        |
| PR11 | ROOF BEAM - DACHBALKEN - PANNE DE TOIT<br>  |     | 1   | 44x140       | 5600        |
| PR21 | ROOF BEAM - DACHBALKEN - PANNE DE TOIT<br>  |     | 4   | 44x140       | 5600        |
|      | FLOOR BOARDS - FUSSBODENBRETTER - LAME DE PLANCHER<br>                                |     | 43  | 90x18        | 3808        |
|      | ROOF BOARDS - DACHBRETTER - VOLIGES<br>   |     | 126 | 90x18        | 2300        |
|      | FLOOR FILLET-FUSSBODENLEISTE - CORNIERE DE FINITION DU PLANCHER<br>                  |     |     | 18x18        | 15.23       |
|      | ROOFING FELT FILLET - DACHPAPPENLEISTE - BAGUETTE DE FIXATION DU FEUTRE BITUMEUX<br> |     | 4   | 18x58        | 2350        |

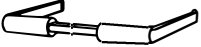
| Pos | 04.01.2011  | 7/8   | St. | Profile (mm) | Lenght (mm) |
|-----|---|---|-----|--------------|-------------|
|     | EAVES BOARD - TRAUFBRETT - BANDEAU DE TOIT  |    | 4   | 18x90        | 2800        |
|     | ROOF EDGE REINFORCEMENT - DACHRANDVERSTÄRKUNG - CORNIERE DE RENFORT DE BORD DE TOIT                             |    | 4   | 28x34        | 2800        |
|     | STORM PROTECTION - STURMLEISTE<br>LATTE ANTI-TEMPETE  |     | 4   | 22x45        | 2000        |
|     | GABLE MOULDING - GIEBELLEISTE<br>PLANCHE DE RIVE  |     | 4   | 18x120       | 2350        |
|     | WINDOW HANDLE FITTINGS-FENSTERGRIFF - POIGNÉE D'OUVERTURE DE FENETRE  |    | 1   |              |             |
|     | SCREW FOR GABLE SEGMENT - SCHRAUBEN FÜR DECKBLATT - VIS POUR FIXATION LOSANGE DE FINITION                       |    | 4   | 3.5x35       |             |
|     | SCREW FOR DOORSTEP - SCHRAUBEN FÜR SWELLE - VIS DE FIXATION DU SEUIL DE PORTE                                   |    | 2   | 4.5x65       |             |
|     | SCREW FOR GABLE MOULDING - SCHRAUBEN FÜR GIEBELLEISTE - VIS DE FIXATION POUR PLANCHE DE RIVE                    |    | 32  | 3.5x50       |             |
|     | SCREW FOR EAVES BOARDS - SCHRAUBEN FÜR TRAUFBRETT - VIS DE FIXATION POUR BANDEAU DE TOIT                        |    | 28  | 4x40         |             |
|     | SCREW FOR ROOF EDGE REINFORCEMENT - SCHRAUBEN FÜR DACHRANDVERSTÄRKUNG - VIS POUR RENFORT DE BORD DE TOIT        |    | 28  | 4x40         |             |
|     | SCREW FOR ROOF BEAMS - SCHRAUBEN FÜR DACHBALKEN - VIS POUR PANNE DE TOIT  |   | 14  | 5x120        |             |
|     | SCREW FOR 1. WALL BEAM - SCHRAUBE FÜR 1. BOHLENREIHE - VIS DE FIXATION DES FONDATIONS                           |  | 7   | 5x90         |             |
|     | SCREW FOR FUNDAMENT - SCHRAUBEN ZUR BEFESTIGUNG FUNDAMENT - VIS POUR FONDATION                                  |  | 22  | 5x90         |             |
|     | ZN NAIL FOR FLOOR FILLET - ZN NÄGEL FÜR FUSSBODENLEISTE - POINTE POUR CORNIERE DE FINITION DU PLANCHER          |  | 31  | 1.4x40       |             |
|     | HAMMER BLOCK - SCHLAGHOLZ - CALLE DE FRAPPE   |  | 1   |              |             |
|     | ZN NAIL FOR ROOFING FELT FILLET - ZN NÄGEL FÜR DACHPAPPENLEISTE - POINTE POUR BAGUETTE FIXATION FEUTRE BITUMEUX |  | 24  | 2x40         |             |
|     | BOLT FOR WINDOW HANDLE FITTINGS - BOLZEN FÜR FENSTERGRIFF BESCHLAG - BOULON POUR POIGNÉE D'OUVERTURE DE FENETRE |  | 2   |              |             |
|     | GABLE SEGMENT-DECKBLATT - LOSANGE DE FINITION   |  | 2   |              |             |
|     | NUT FOR STORM PROTECTION - SCHRAUBENMUTTER FÜR STURMLEISTE - ÉCROU POUR LAME ANTI-TEMPETE                       |  | 8   |              |             |
|     | BOLT FOR STORM PROTECTION - BOLZEN FÜR STURMLEISTE - VIS POUR LAME ANTI-TEMPETE                                 |  | 8   |              |             |
|     | WASHER FOR STORM PROTECTION - DICHTSCHEIBE FÜR STURMLEISTE - RONDELLE POUR LAME ANTI-TEMPETE                    |  | 8   |              |             |
|     | ZN NAIL FOR ROOF - ZN NÄGEL FÜR DACHBRETT - POINTE POUR TOIT  |  | 525 | 2x50         |             |
|     | ZN NAIL FOR FLOOR - ZN NÄGEL FÜR FUSSBODENBRETT - CLOUS POUR PLANCHER   |  | 308 | 2x50         |             |
|     | SET OF DOOR LOCK COVERS - SCHLOSSBLENDEN - SET DE GARNITURES DE SERRURE DE PORTE                                |  | 1   |              |             |
|     | DOOR HANDLE FITTINGS-TÜRGRIF - SET DE GARNITURES DE SERRURE DE PORTE  |  | 1   |              |             |

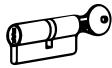
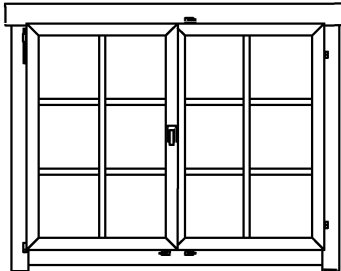
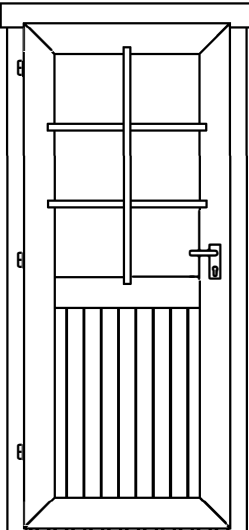
| Pos | 04.01.2011 CYLINDER -   | 8/8   | St. | Profile (mm) | Lenght (mm) |
|-----|---|---|-----|--------------|-------------|
|     | ZYLINDERSCHLOSS - CYLINDRE DE SERRURE WINDOW-   |  | 1   |              |             |
|     | FENSTER-FENETRE 1290x882<br>   | TAK.1.106.SSV.a   | 1   |              |             |
|     | DOOR-TÜR - PORTE 835x1957<br> | UK.2.056.SVV.MM   | 1   |              |             |
|     |   |   |     |              |             |
|     |   |   |     |              |             |
|     |   |   |     |              |             |
|     |   |   |     |              |             |
|     |   |   |     |              |             |
|     |   |   |     |              |             |
|     |   |   |     |              |             |
|     |   |   |     |              |             |
|     |   |   |     |              |             |
|     |   |   |     |              |             |
|     |   |   |     |              |             |
|     |   |   |     |              |             |