

*Elvira*

1/13

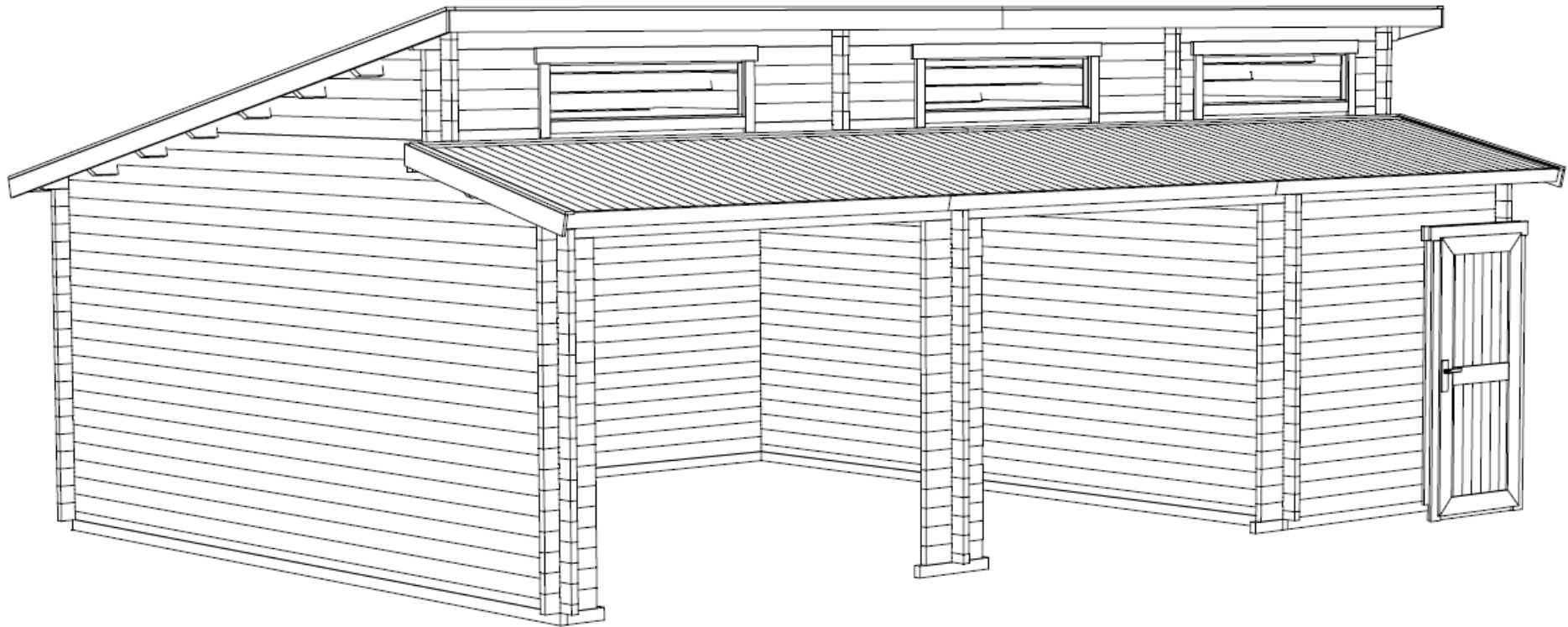

18.08.2015

GROUNDPLAN - GRUNDPLAN - PLAN DE MASSE

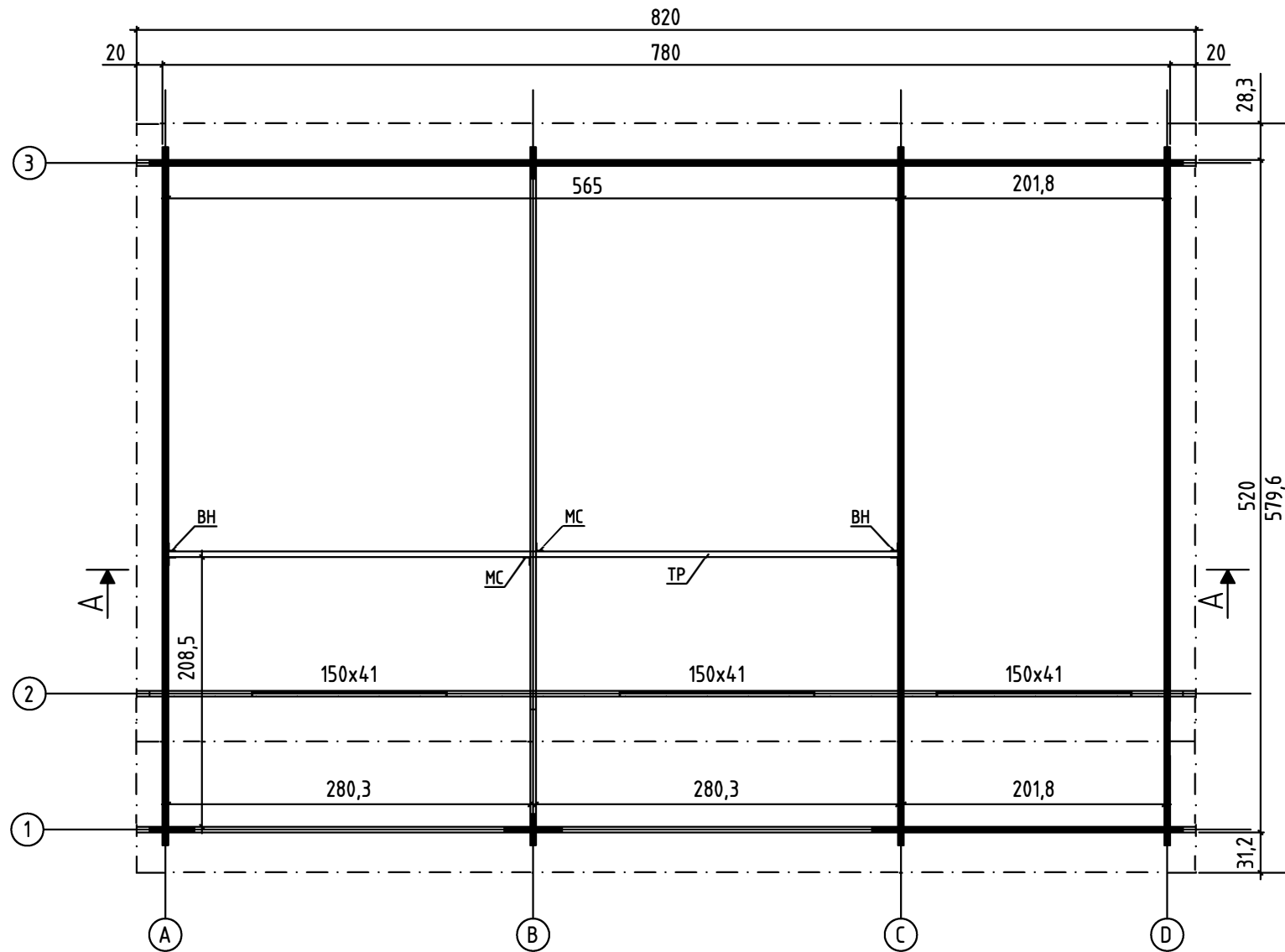

FOUNDATION - FUNDAMENT - FONDATION

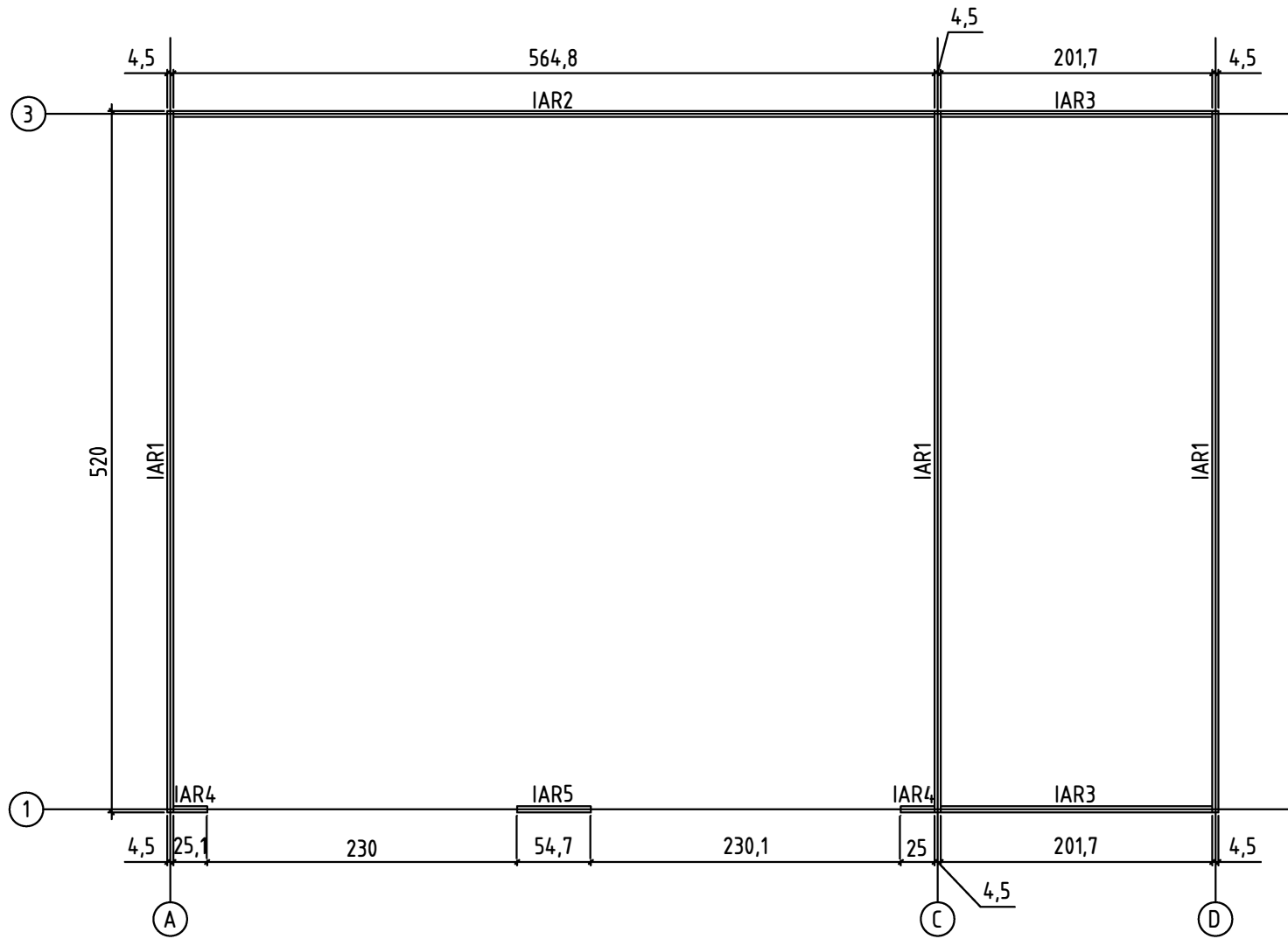

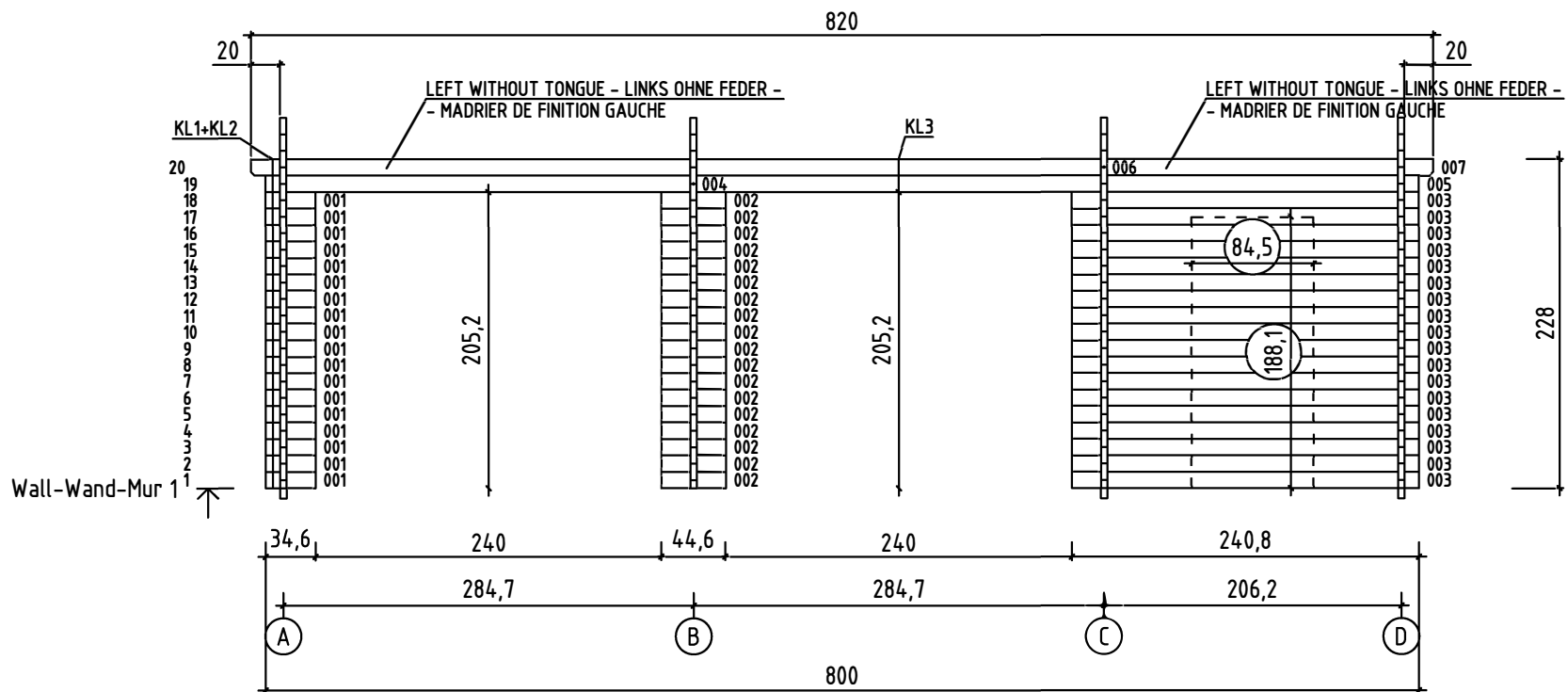

A SINGLE DOOR (83.5x185 CM) HAS BEEN DELIVERED TOGETHER WITH THE BUILDING. YOU CAN CHOOSE THE LOCATION FOR THE DOOR BY YOURSELF BY CUTTING THE WALL LOGS AS SHOWN IN THE PICTURE (SEE THE DOTTED LINE)

IM LIEFERUMFANG IST EINE EINZELTÜR ENTHALTEN. DAFÜR SIND ABER WERKSSEITIG KEINE AUSSPARUNGEN VORGESEHEN SO DASS SIE TÜR INDIVIDUELL VERBAUEN KÖNNEN. EINE ANLEITUNG HIERFÜR ENTNEHMEN SIE BITTE DER MONTAGEANLEITUNG (SIEHE BILD)

LE POSITIONNEMENT DE LA PORTE DE SERVICE NÉCESSITE LA DÉCOUPE PRÉALABLE DES MADRIERS. VEILLEZ RESPECTER LES COTES DE DÉCOUPES DANS LES MADRIERS INDQUÉES SUR LE SCHÉMA. VOUS POUVEZ POSITIONNER, SELON VOTRE CONVENANCE, LES OUVERTURES DE CHAQUE CÔTÉ OU À L'ARRIÈRE DU GARAGE.

RIGHT WITHOUT TONGUE - RECHT OHNE FEDER - MADRIER DE FINITION DROIT

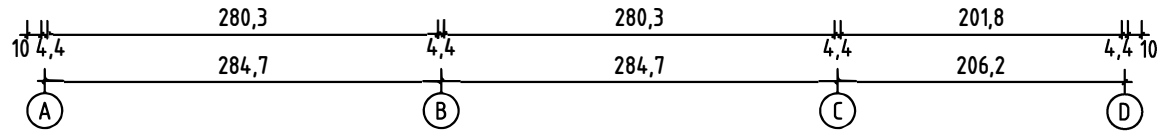
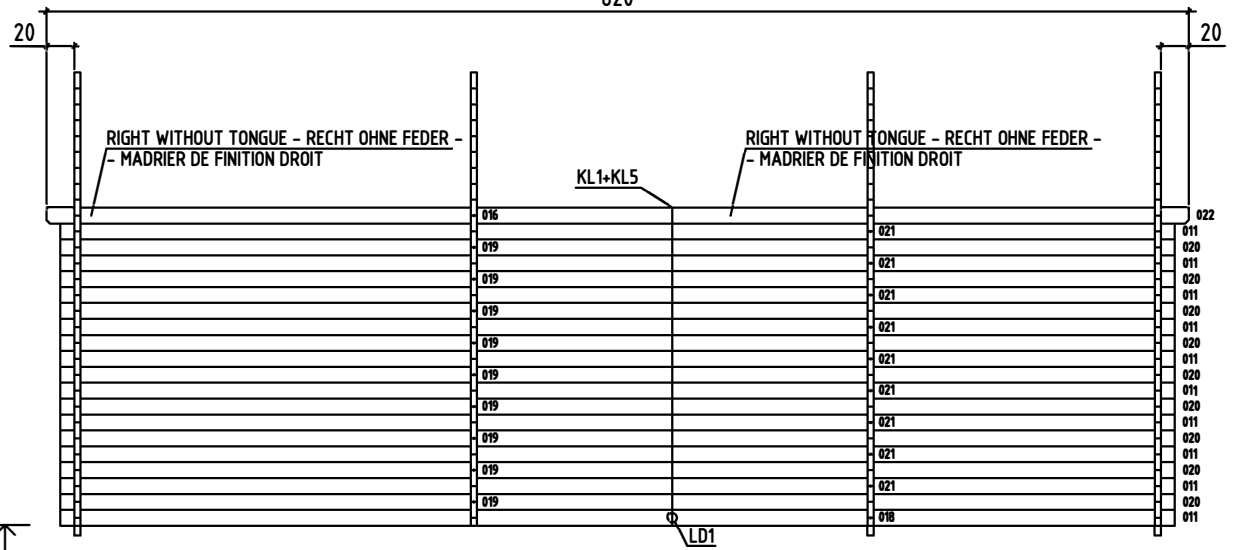
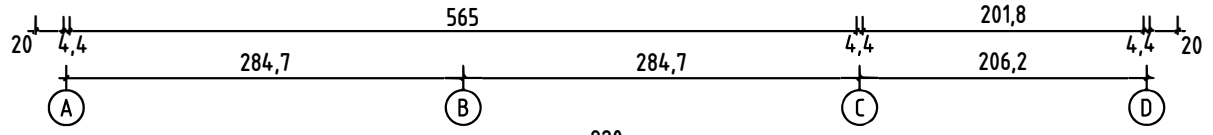
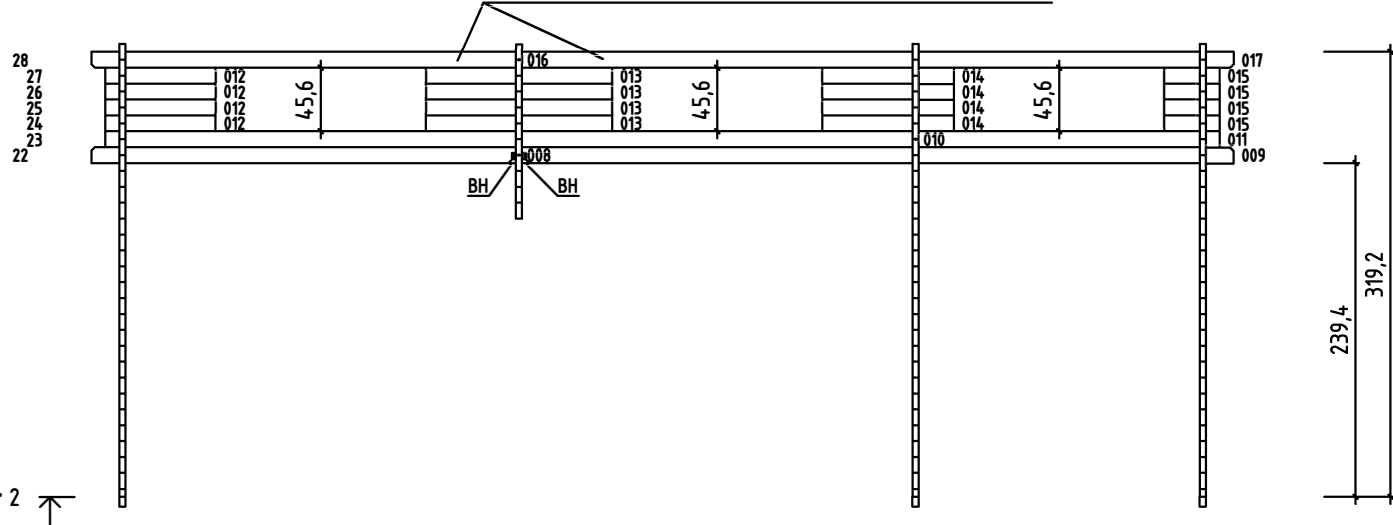

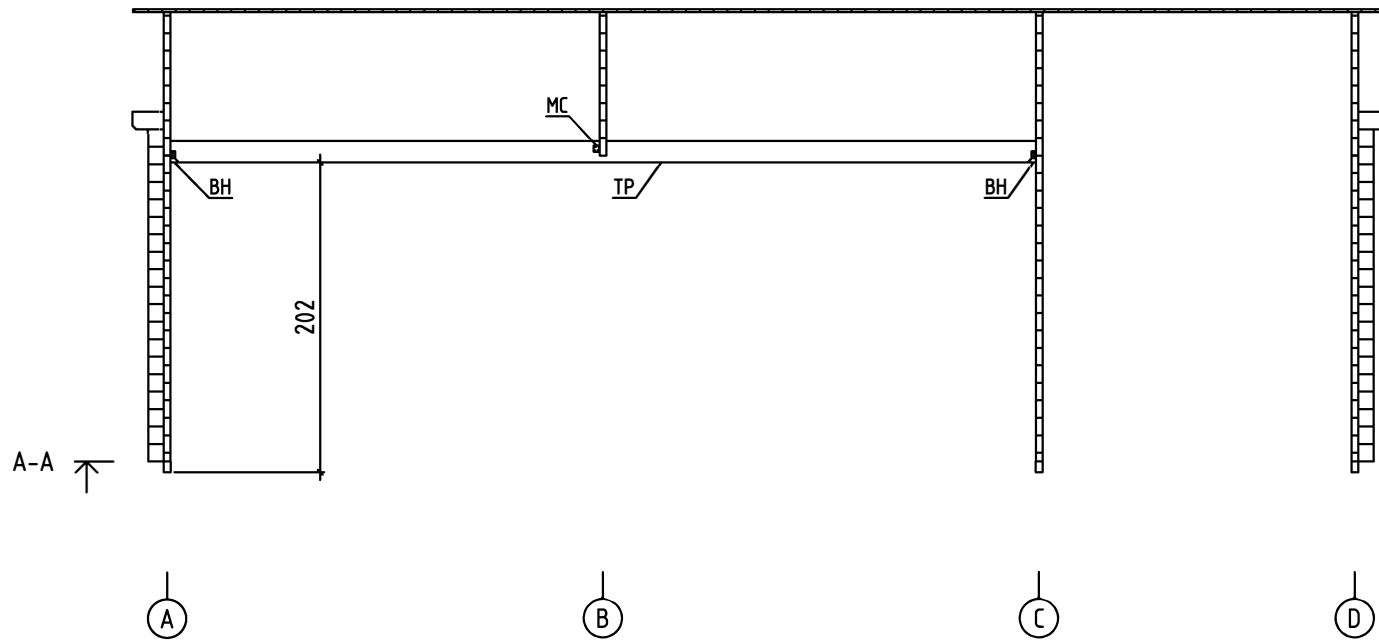

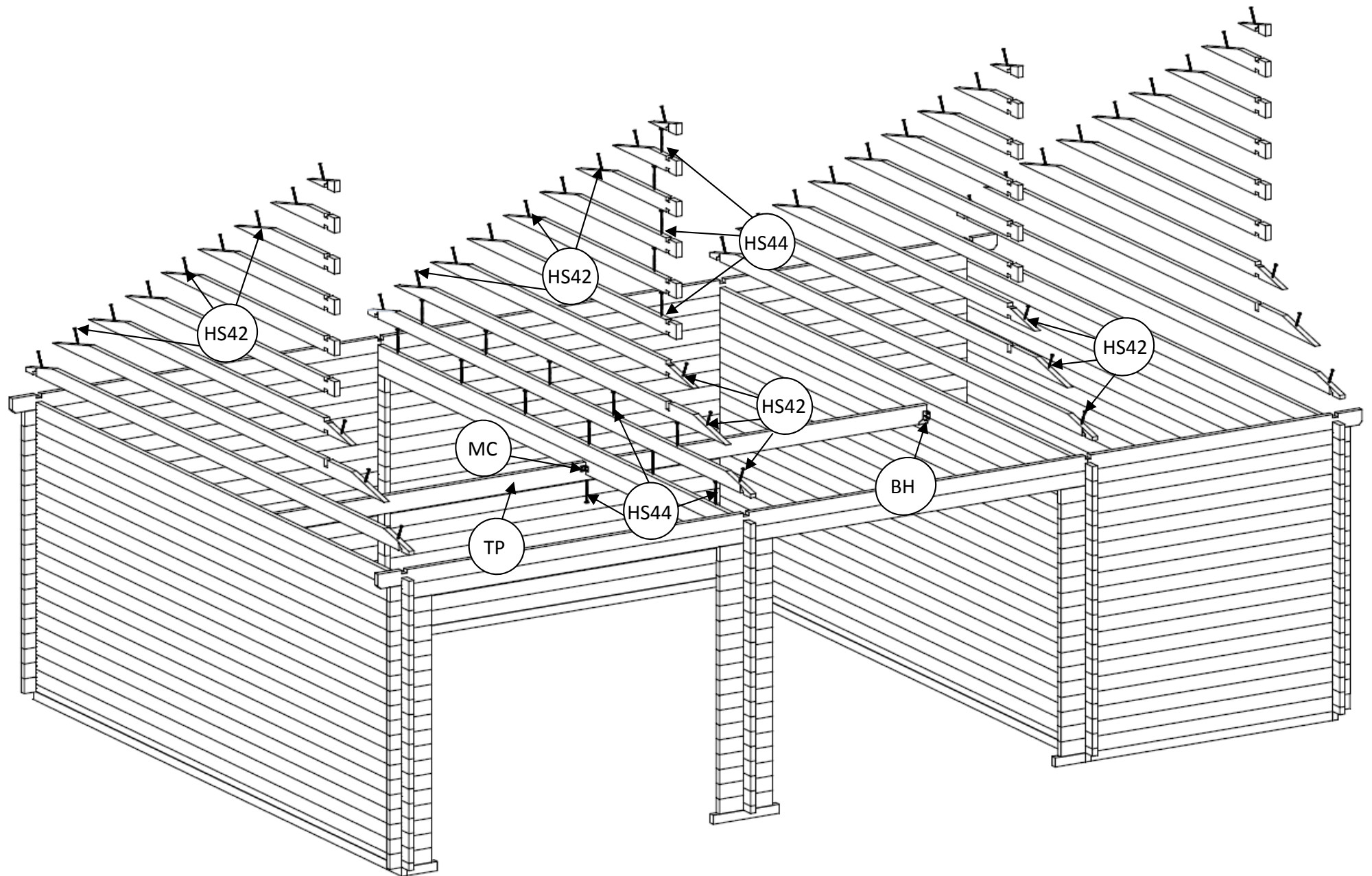

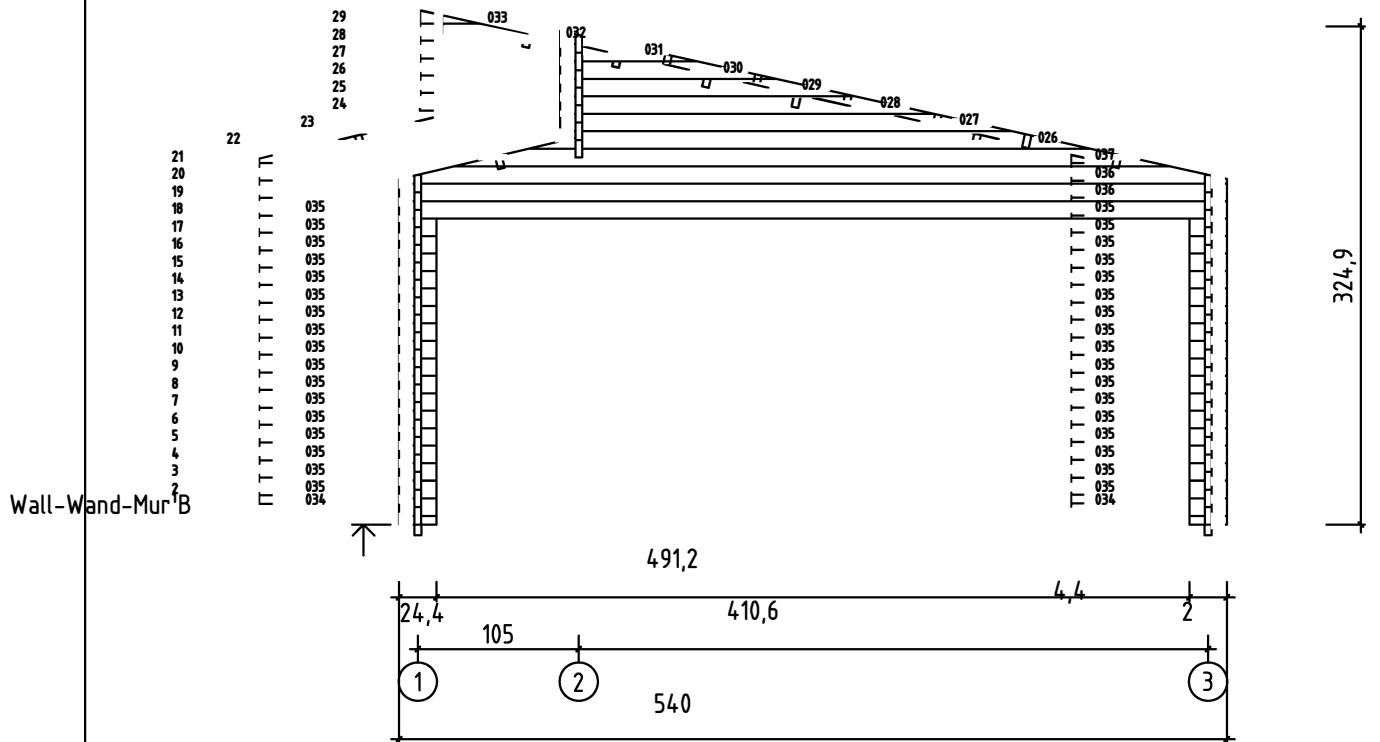
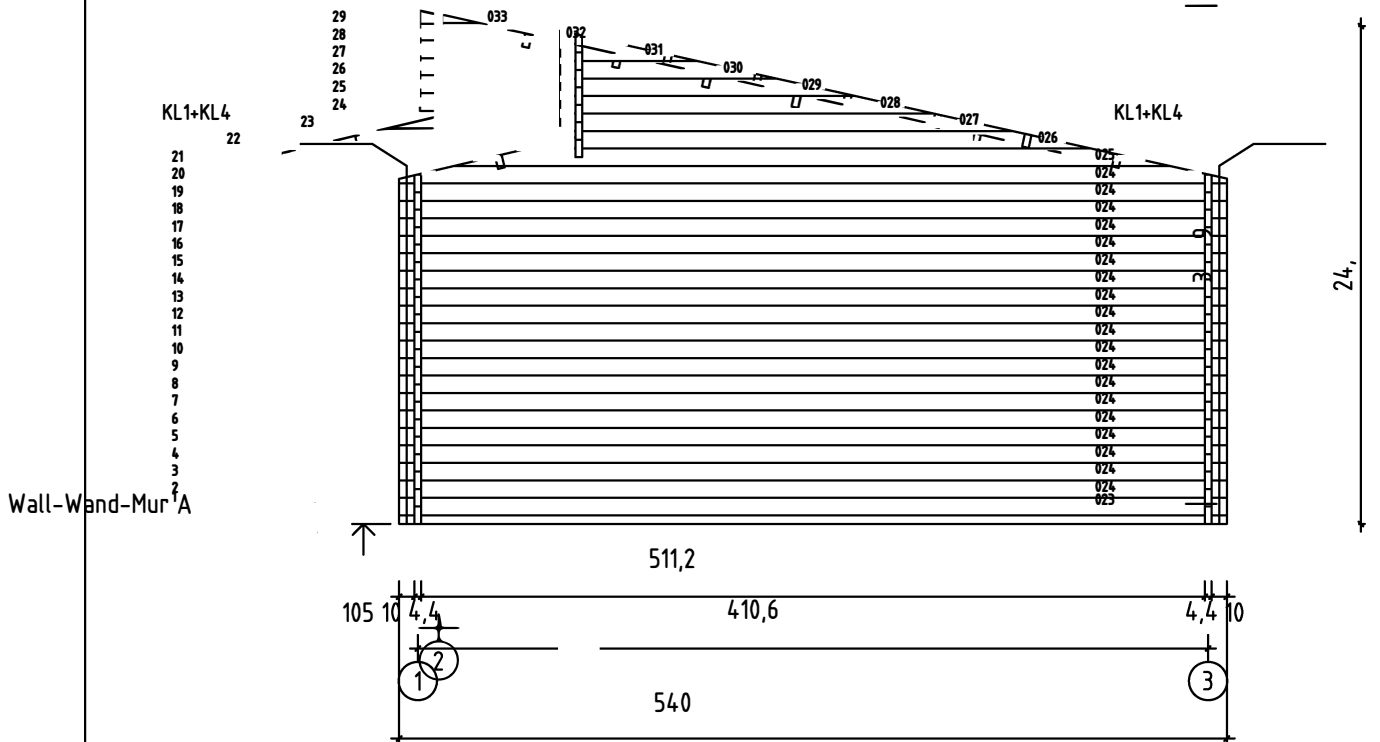



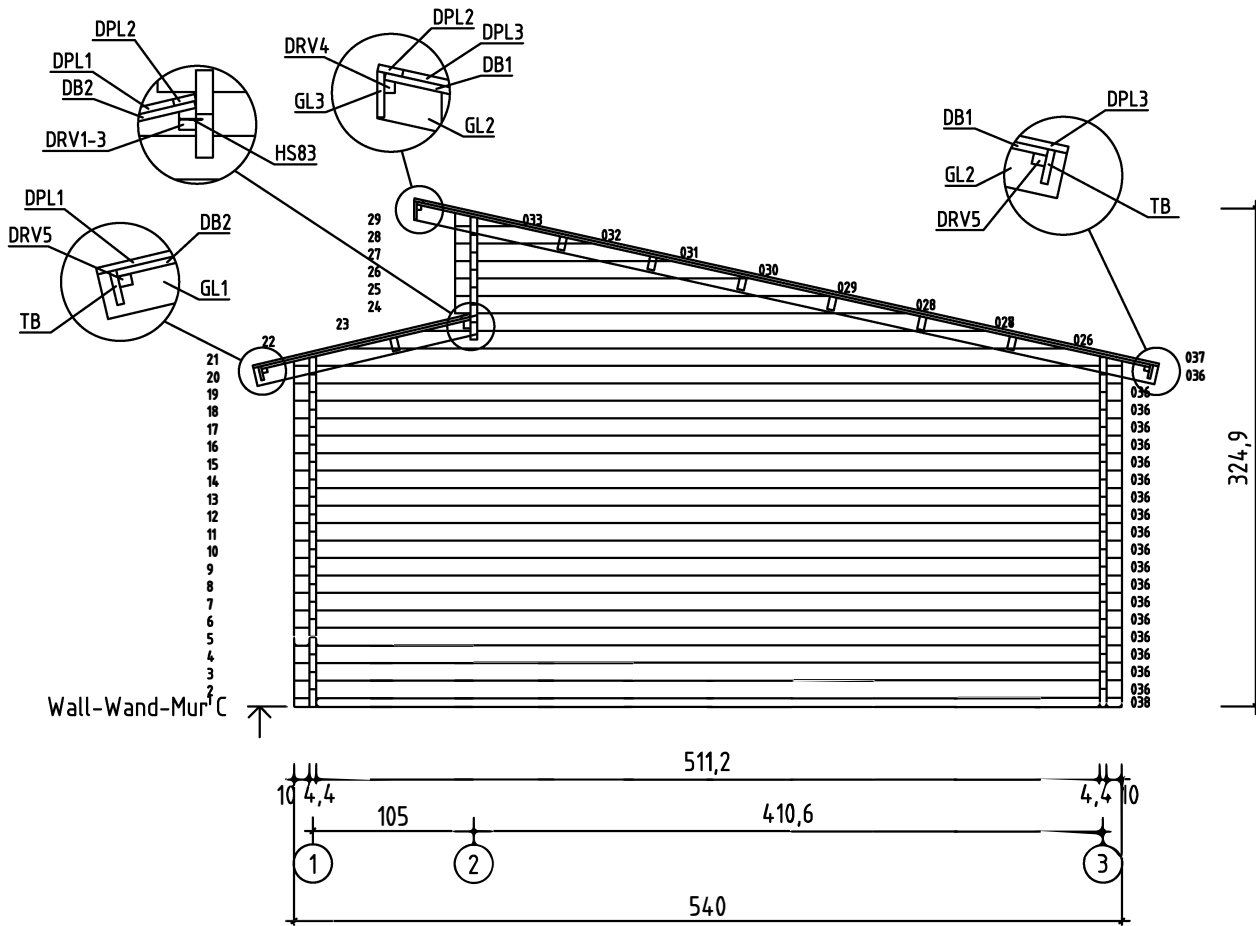



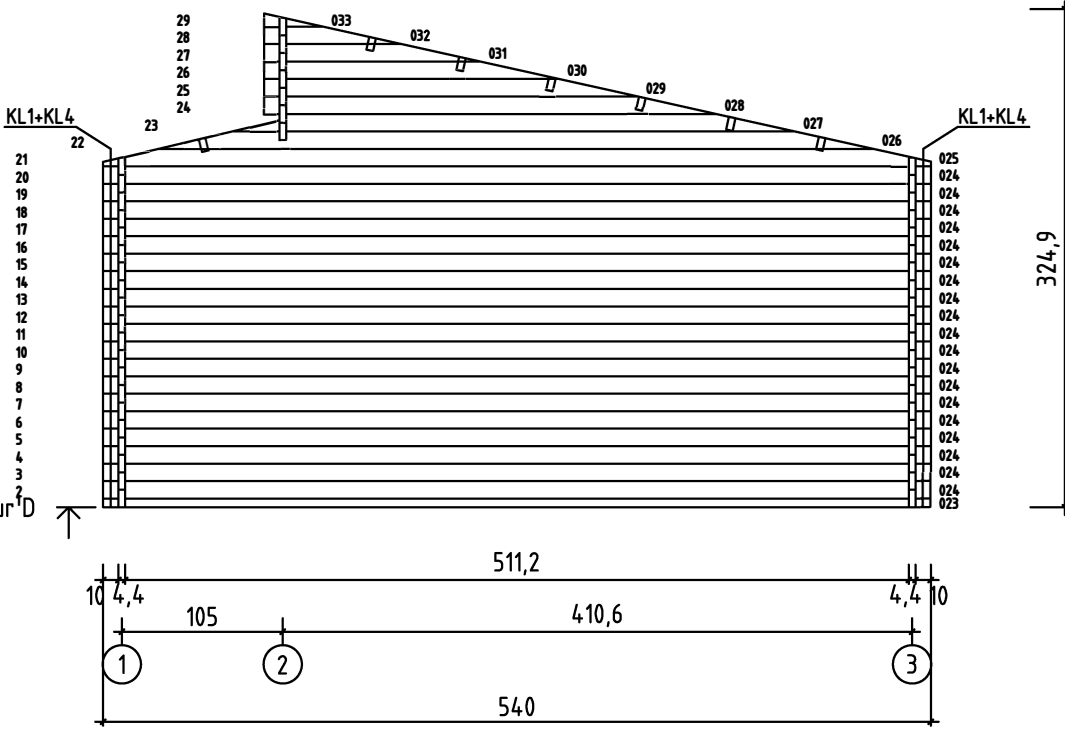





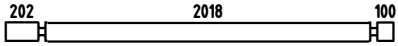
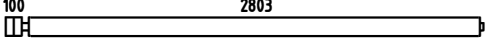
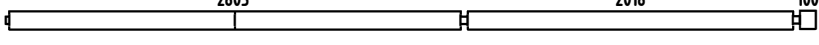
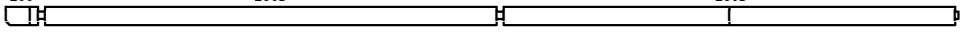
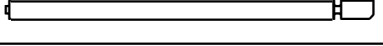
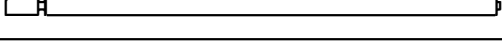
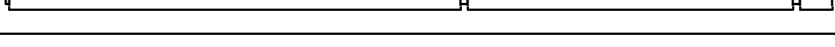
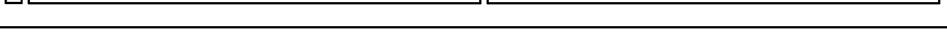
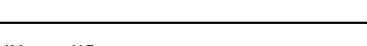
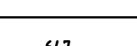
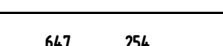
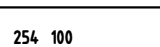

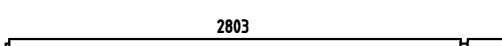
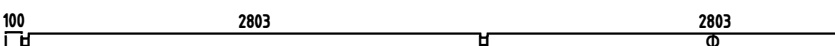
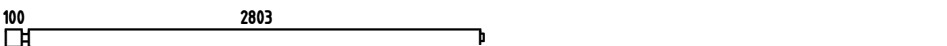
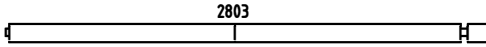
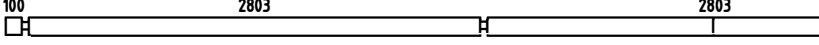
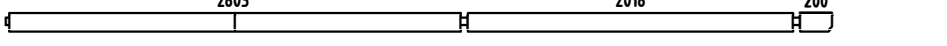
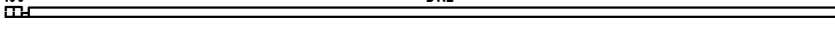
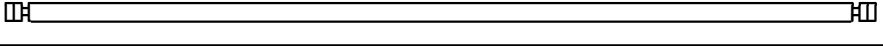





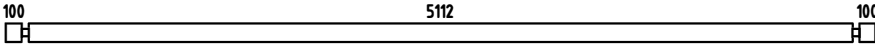
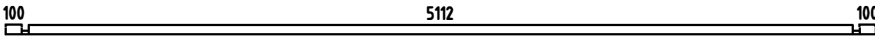
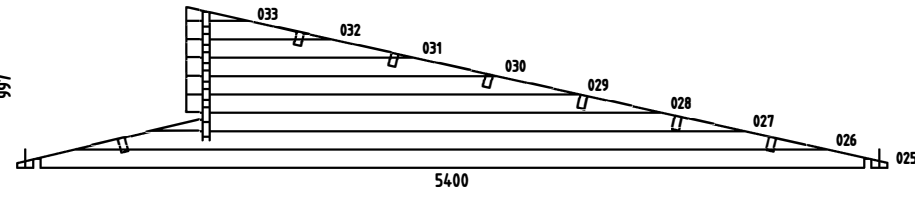
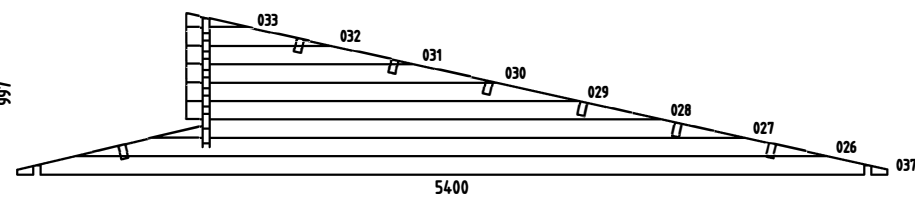
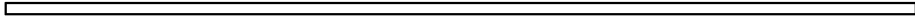
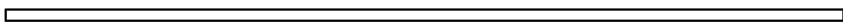



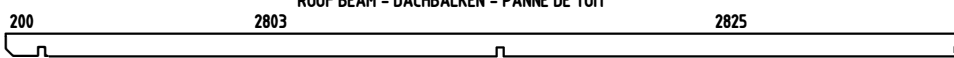
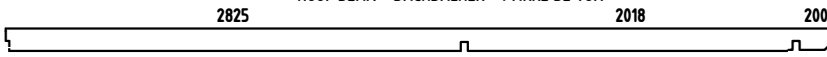
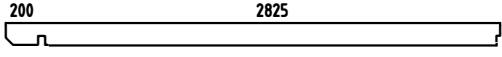
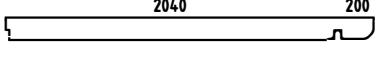





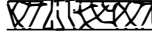

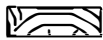

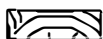
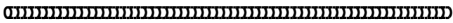

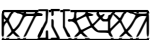

Wall-Wand-Mur<sup>C</sup>

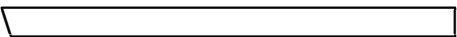
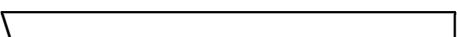
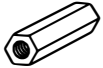



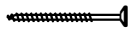
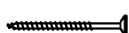
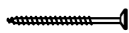

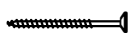







Wall-Wand-Mur<sup>D</sup>

Pos	18.08.2015	Piecelist - Stücklist - Liste des composants	10/13	Q.	P. (mm)	L. (mm)
001				18	44x114	346
002				18	44x114	446
003				18	44x114	2408
004				1	44x114	2969
005				1	44x114	5031
006				1	44x120	5916
007				1	44x120	2284
008				1	44x114	3069
009				1	44x114	5131
010				1	44x114	5816
011				11	44x114	2184
012				4	44x114	791
013				4	44x114	1338
014				4	44x114	945
015				4	44x114	398
016				2	44x120	3069
017				1	44x120	5131
018				1	44x114	5816
019				9	44x114	2969
020				9	44x114	5031
021				9	44x114	5816
022				1	44x120	5131
023				2	44x57	5400
024				38	44x114	5400
034				2	44x57	244

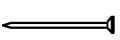
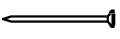
Pos	18.08.2015	Piecelist - Stücklist - Liste des composants	11/13	Q.	P. (mm)	L. (mm)
035				34	44x114	244
036				21	44x114	5400
038				1	44x57	5400
WA-1 WD-1				1 1		
WB-1 WC-1				1 1		
IAR2		FOUNDATION - FUNDAMENT - FONDATION		1	45x70	5648
IAR1		FOUNDATION - FUNDAMENT - FONDATION		3	45x70	5200
IAR3		FOUNDATION - FUNDAMENT - FONDATION		2	45x70	2017
IAR5		FOUNDATION - FUNDAMENT - FONDATION		1	45x70	547
IAR4		FOUNDATION - FUNDAMENT - FONDATION		2	45x70	251
A-PR1		ROOF BEAM - DACHBALKEN - PANNE DE TOIT		3	44x140	5916
A-PR4		ROOF BEAM - DACHBALKEN - PANNE DE TOIT		4	44x140	5131
A-PR3		ROOF BEAM - DACHBALKEN - PANNE DE TOIT		4	44x140	3069
A-PR2		ROOF BEAM - DACHBALKEN - PANNE DE TOIT		3	44x140	2284
DB1	ROOF BOARDS - DACHBRETTER - VOLIGES			92	90x18	4900
DB2	ROOF BOARDS - DACHBRETTER - VOLIGES			92	90x18	1400
DRV1	ROOF EDGE REINFORCEMENT - DACHRANDVERSTÄRKUNG - CORNIERE DE RENFORT DE BORD DE TOIT			2	44x57	200
DRV2	ROOF EDGE REINFORCEMENT - DACHRANDVERSTÄRKUNG - CORNIERE DE RENFORT DE BORD DE TOIT			1	44x57	2016
DRV3	ROOF EDGE REINFORCEMENT - DACHRANDVERSTÄRKUNG - CORNIERE DE RENFORT DE BORD DE TOIT			2	44x57	2801
DRV4	ROOF EDGE REINFORCEMENT - DACHRANDVERSTÄRKUNG - CORNIERE DE RENFORT DE BORD DE TOIT			2	28x34	4100
GL3	GABLE MOULDING - GIBELLEISTE - PLANCHE DE RIVE			2	18x120	4100

Pos	18.08.2015	Piecelist - Stücklist - Liste des composants	12/13	Q.	P. (mm)	L. (mm)
DPL1	ROOFING FELT FILLET - DACHPAPPENLEISTE - BAGUETTE DE FIXATION DU FEUTRE BITUMEUX			2	18x58	1455
DPL2	ROOFING FELT FILLET - DACHPAPPENLEISTE - BAGUETTE DE FIXATION DU FEUTRE BITUMEUX			4	18x58	4060
DPL3	ROOFING FELT FILLET - DACHPAPPENLEISTE - BAGUETTE DE FIXATION DU FEUTRE BITUMEUX			2	18x58	4975
KL1	TREADED ROD M10 - GEWINDESTANGE M10 - TIGE FILETÉE M10			6		2000
KL2	TREADED ROD M10 - GEWINDESTANGE M10 - TIGE FILETÉE M10			1		310
KL3	TREADED ROD M10 - GEWINDESTANGE M10 - TIGE FILETÉE M10			1		260
KL4	TREADED ROD M10 - GEWINDESTANGE M10 - TIGE FILETÉE M10			4		300
KL5	TREADED ROD M10 - GEWINDESTANGE M10 - TIGE FILETÉE M10			1		220
TB	EAVES BOARD - TRAUFBRETT - BANDEAU DE TOIT			4	18x90	4100
DRV5	ROOF EDGE REINFORCEMENT - DACHRANDVERSTÄRKUNG - CORNIERE DE RENFORT DE BORD DE TOIT			4	28x34	4100
TP	SUPPORT BEAM FOR GATE FRAME - STUTZBOHLE FÜR TORZARGE - MADRIER DE SUPPORT DU CADRE DE LA PORTE BASCULANTE			1	44x140	5648
GL1	GABLE MOULDING - GIEBELLEISTE - PLANCHE DE RIVE			2	18x120	1500
GL2	GABLE MOULDING - GIEBELLEISTE - PLANCHE DE RIVE			2	18x120	4975
KL4	LENGTHENING BOLT FOR TREADED ROD - VERLÄNGERUNGSMUTTER FÜR GEWINDESTANGE - MANCHON DE RACCORDEMENT DE TIGE FILETÉE			6		
KL1	DRIVE NUT TREADED ROD - EINSHLAGMUTTER FÜR GEWINDESTANGE - ÉCROU A FRAPPER POUR TIGE FILETÉE			7		
KL2	NUT FOR TREADED ROD - MUTTER FÜR GEWINDESTANGE - ÉCROU POUR TIGE FILETÉE			7		
KL3	PLAIN WASHER TREADED ROD - UNTERLEGSCHLEIBE FÜR GEWINDESTANGE - RONDELLE PLATE POUR TIGE FILETÉE			7		
LD1	LID FOR TREADED ROD HOLE - ABDECKUNG FÜR GEWINDESTANGENÖFFNUNG - COUVERCLE POUR ACCÈS RÉGLAGÉ TIGE FILETÉE			1		
HS83	SCREW FOR ROOF EDGE REINFORCEMENT - SCHRAUBEN FÜR DACHRANDVERSTÄRKUNG - VIS POUR RENFORT DE BORD DE TOIT			23	4.5x80	
HS32	SCREW FOR EAVES BOARDS - SCHRAUBEN FÜR TRAUFBRETT - VIS DE FIXATION POUR BANDEAU DE TOIT			54	4x40	
HS26	SCREW FOR ROOF EDGE REINFORCEMENT - SCHRAUBEN FÜR DACHRANDVERSTÄRKUNG - VIS POUR RENFORT DE BORD DE TOIT			54	4x40	
HS43	SCREW FOR ROOF BEAMS - SCHRAUBEN FÜR DACHBALKEN - VIS POUR PANNE DE TOIT			35	5x120	
HS42	SCREW FOR GABLE - SCHRAUBEN FÜR GIEBEL - VIS POUR FIXATION DES PIGNONS			48	5x120	
HS40	SCREW FOR 1. WALL BEAM - SCHRAUBE FÜR 1. BOHLENREIHE - VIS DE FIXATION DES FONDATIONS			14	5x90	
HS39	SCREW FOR FUNDAMENT - SCHRAUBEN ZUR BEFESTIGUNG FUNDAMENT - VIS POUR FONDATION			8	5x90	

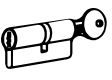
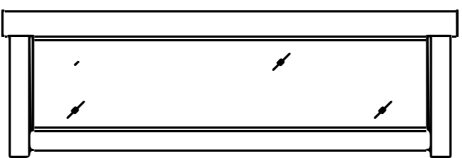
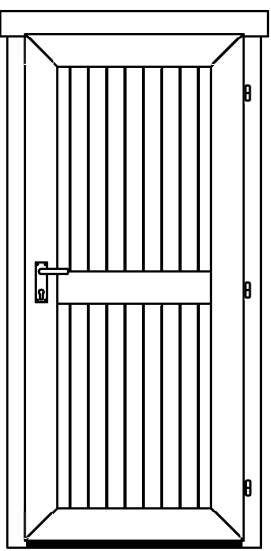
Pos	18.08.2015	Piecelist - Stücklist - Liste des composants	13/13	Q.	P. (mm)	L. (mm)
		SCREW FOR 1. WALL BEAM - SCHRAUBE FÜR 1. BOHLENREIHE - VIS DE FIXATION DES FONDATIONS 		3	6x150	
HS44		SCREW FOR GABLE - SCHRAUBEN FÜR GIEBEL - VIS POUR FIXATION DES PIGNONS 		17	6x180	
		SCREW FOR GABLE MOULDING - SCHRAUBEN FÜR GIEBELLEISTE - VIS DE FIXATION POUR PLANCHE DE RIVE 		66	3.5x50	
MC		METAL CORNER - METALLWINKEL - CORNIERE EN MÉTAL 		2	40x40	
		SCREW FOR METAL CORNER - HOLZSCHRAUBE FÜR METALLWINKEL - VIS POUR COIN EN MÉTAL 		16	4x40	
HS51		SCREW FOR BEAM HOLDER - SCHRAUBEN FÜR BALKENHALTER - VIS DE FIXATION SUPPORT U GALVANISÉ 		216	4x40	
SH44		HAMMER BLOCK - SCHLAGHOLZ - CALLE DE FRAPPE 		1		
MS		SCREW FOR DOORSTEP - SCHRAUBEN FÜR SWELLE - VIS DE FIXATION DU SEUIL DE PORTE 		2	4.5x65	
		ZN NAIL FOR ROOF - ZN NÄGEL FÜR DACHBRETTER - POINTES DE FIXATIONS DES VOLIGES DE TOIT 		1023	2x50	
		ZN NAIL FOR ROOFING FELT FILLET - ZN NÄGEL FÜR DACHPAPPENLEISTE - POINTE POUR BAGUETTE FIXATION FEUTRE BITUMEUX 		66	2x40	
BH		BEAM HOLDER - BALKENHALTER - SUPPORT EN U GALVANISÉ 		18	105x45	
TS3		DOOR HANDLE FITTINGS - TÜRGRIF - SET DE GARNITURES DE SERRURE DE PORTE 		1		
TS4		SET OF DOOR LOCK COVERS - SCHLOSSBLENDEN - SET DE GARNITURES DE SERRURE DE PORTE 		1		
TS6		CYLINDER LOCK - ZYLINDERSCHLOSS - CYLINDRE DE SERRURE 		1		
		WINDOW - FENSTER - FENETRE 1500x410  AK.1.100.SM0.k SGC		3		
		DOOR - TÜR - PORTE 835x1850  UL.2.100.IVP.MMa TC		1		