

Charlotte
1/12

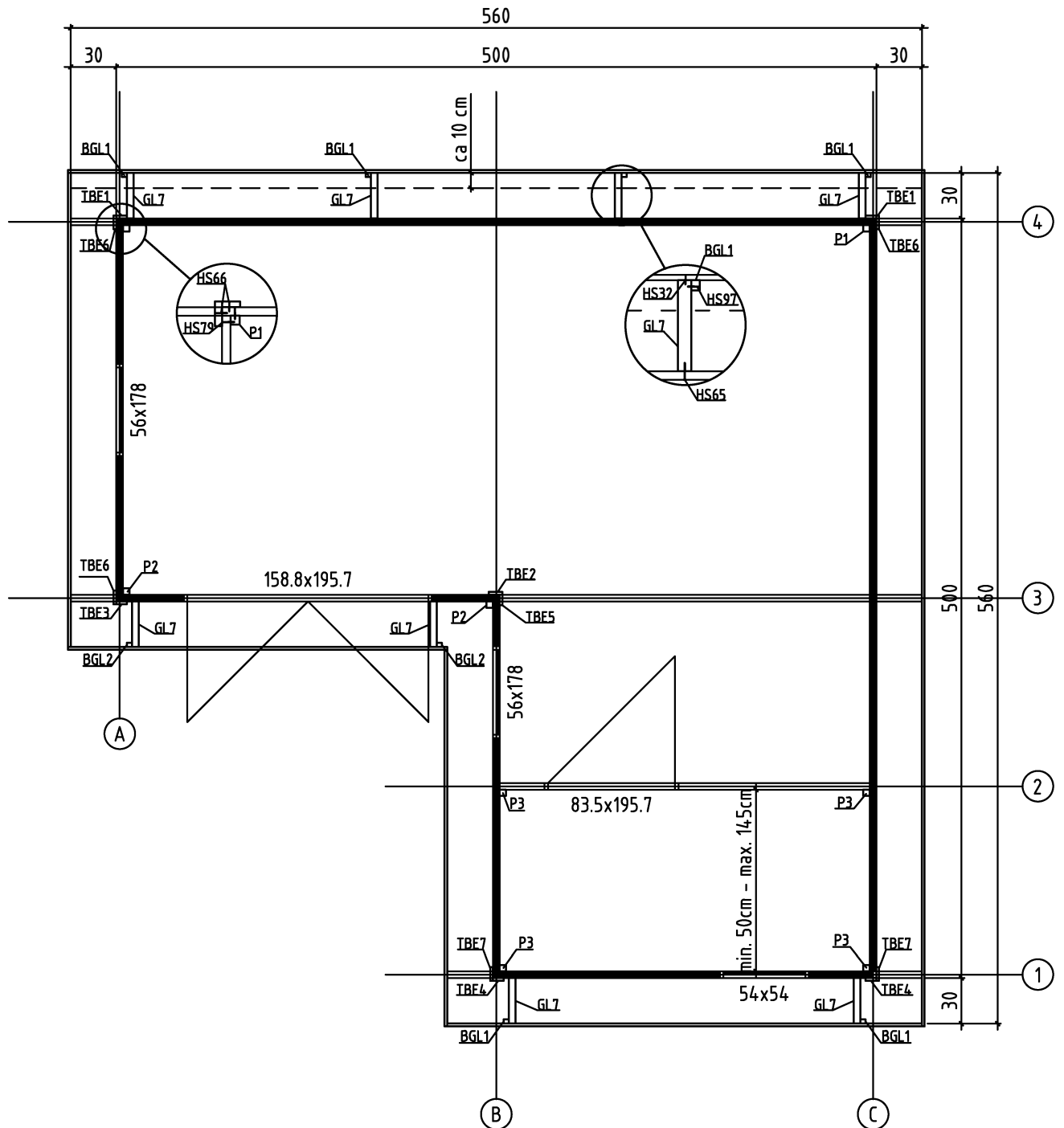

1.09.2016

GROUNDPLAN - GRUNDPLAN - PLAN DE MASSE



FOUNDATION - FUNDAMENT - FONDATION

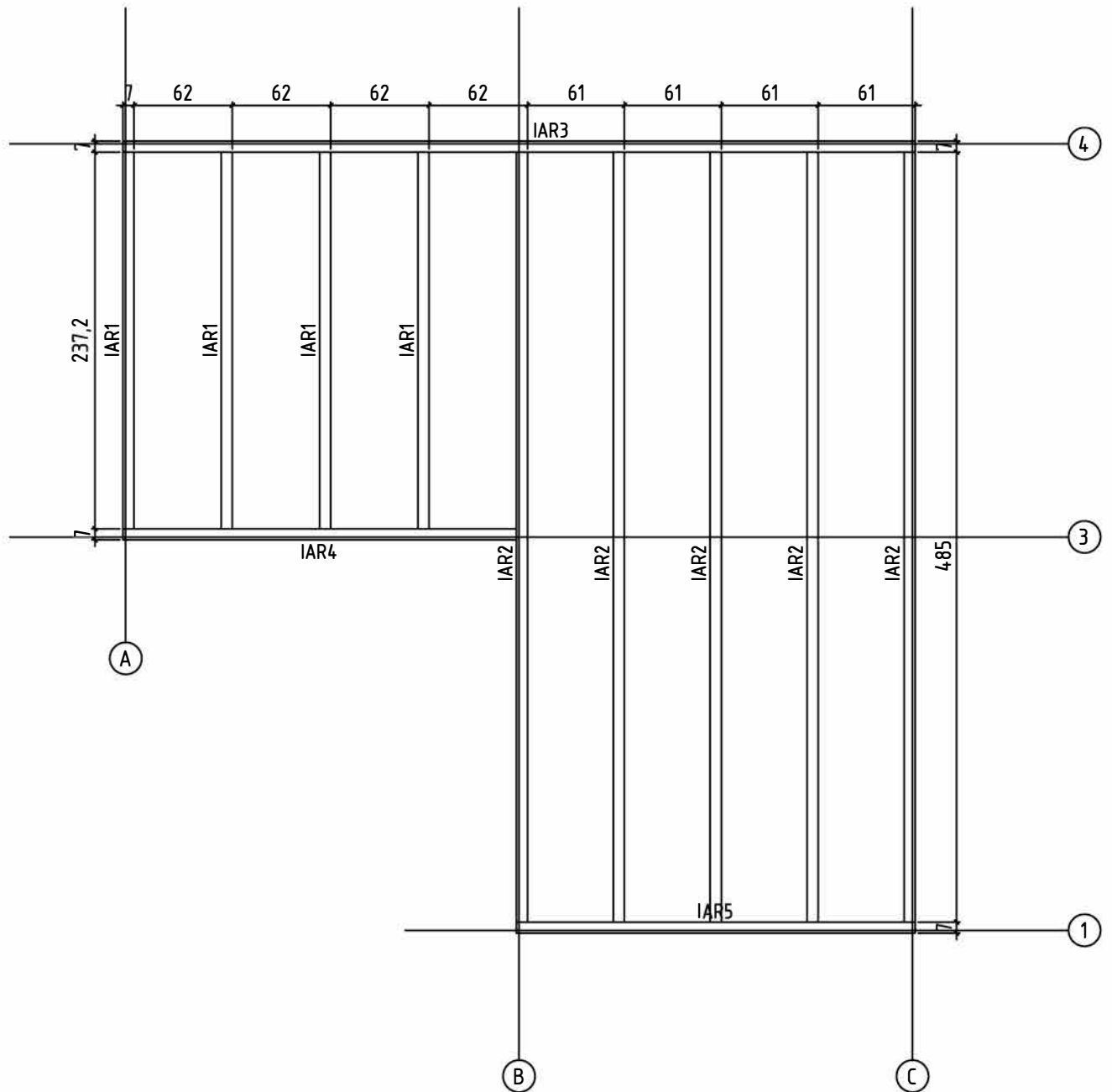

FLOOR BOARDS - FUSSBODENBRETTER - LAME DE PLANCHER

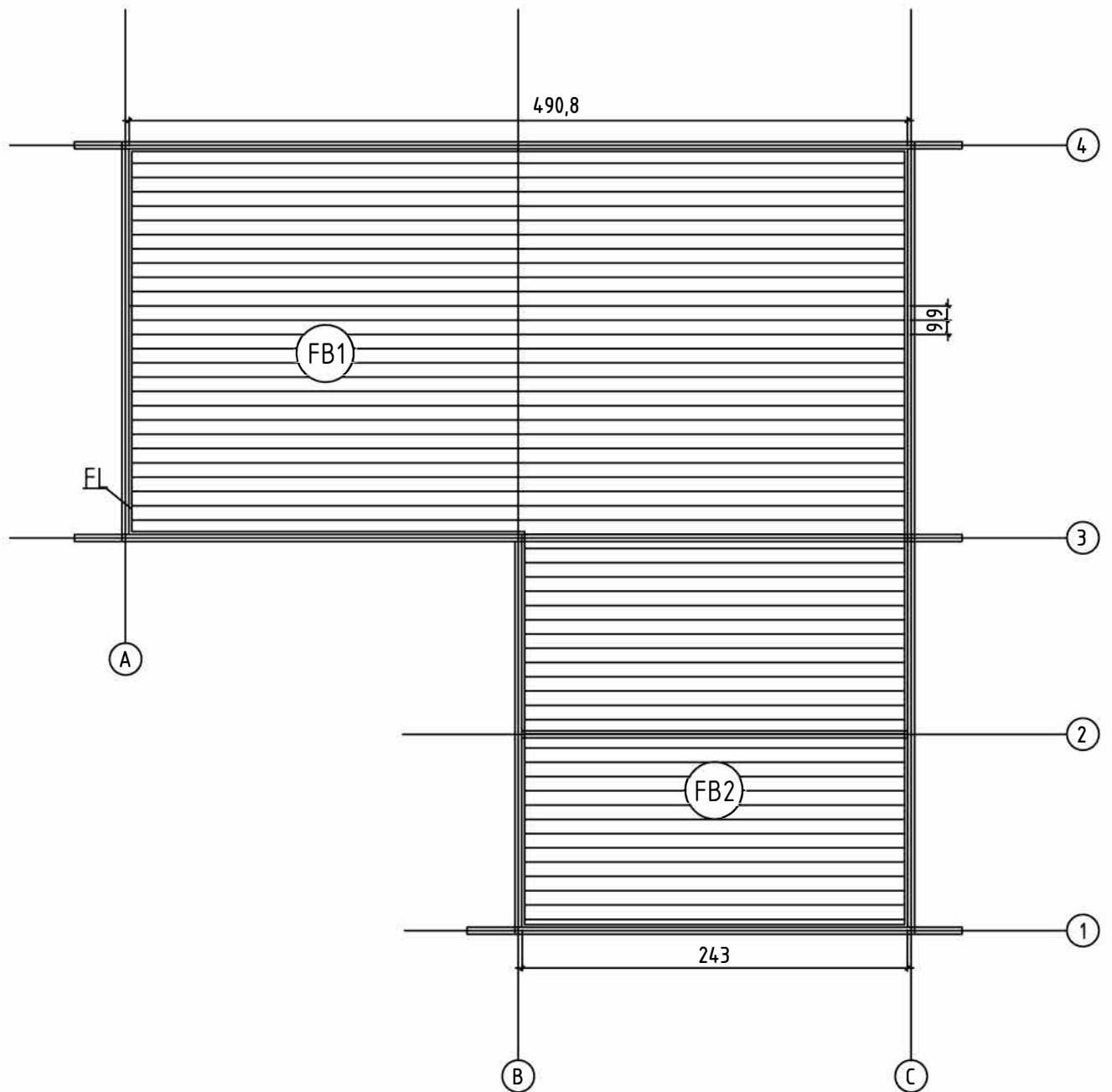

ROOF PLAN - DACH-PLAN - PLAN DU TOIT

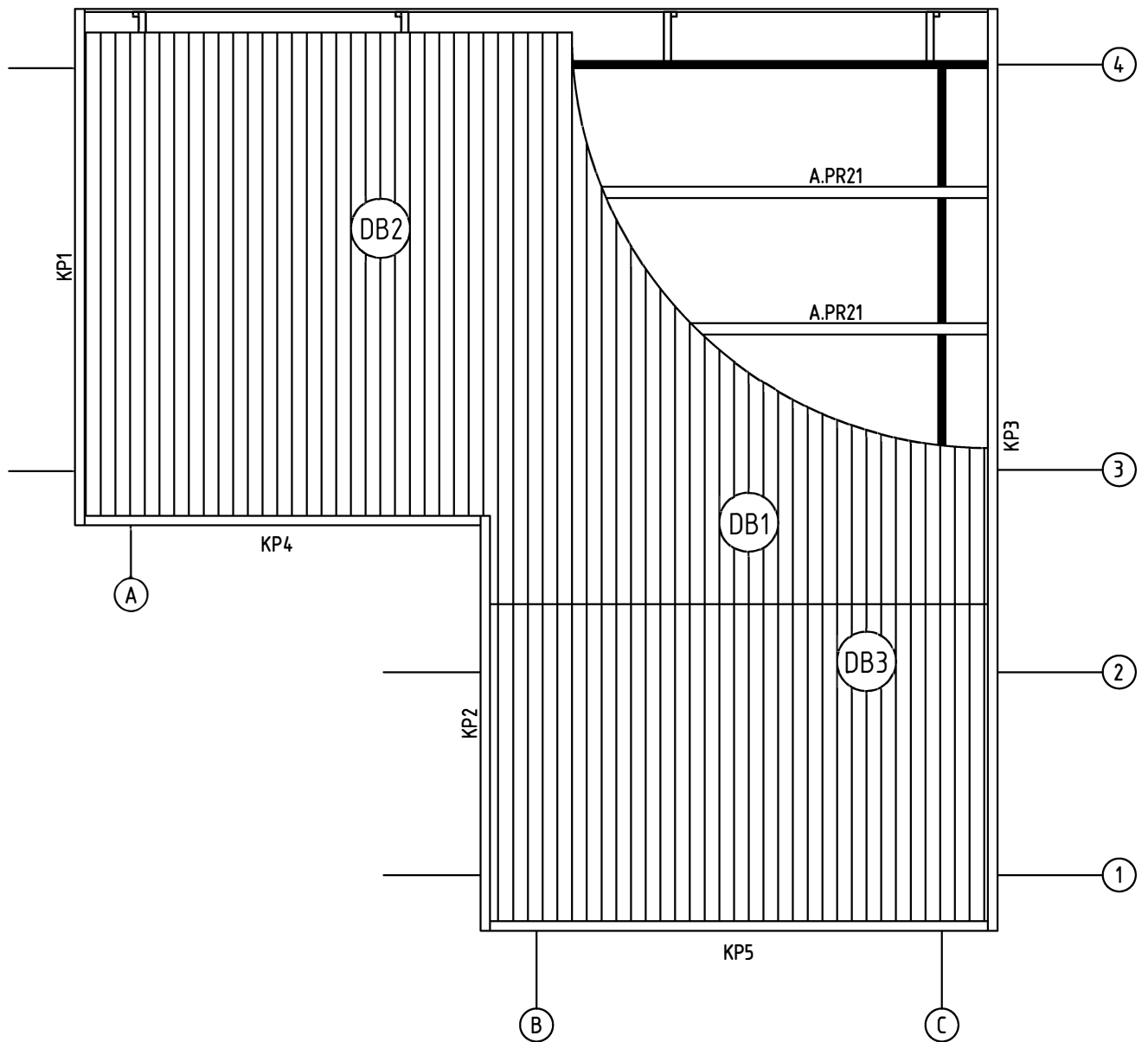

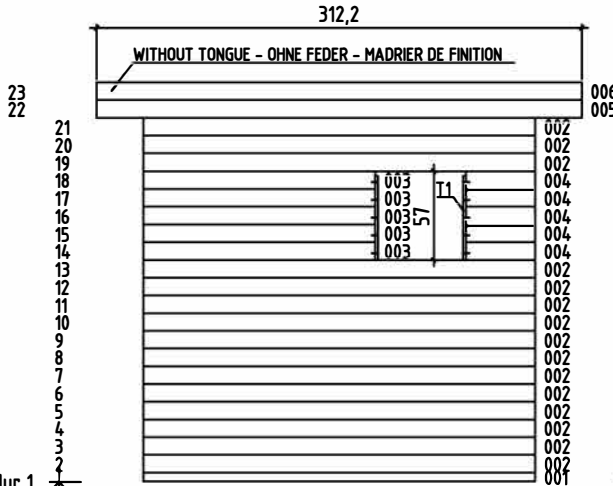

Wall-Wand-Mur 1

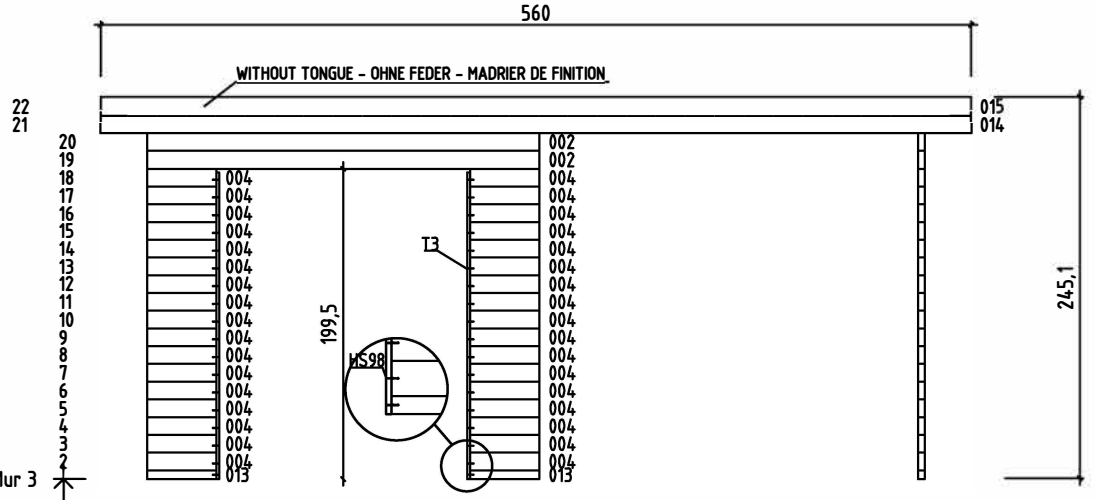
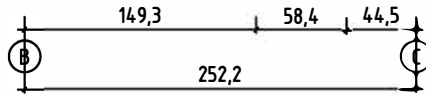

Wall-Wand-Mur 3

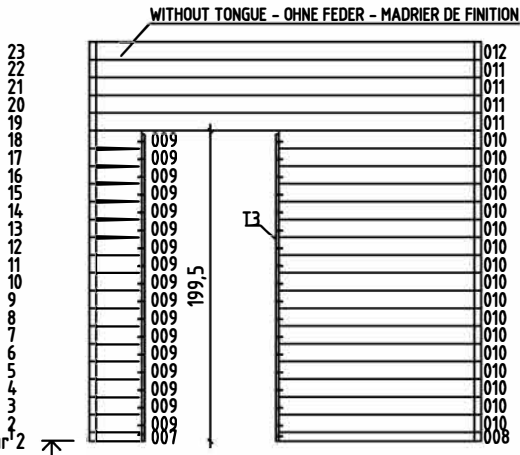
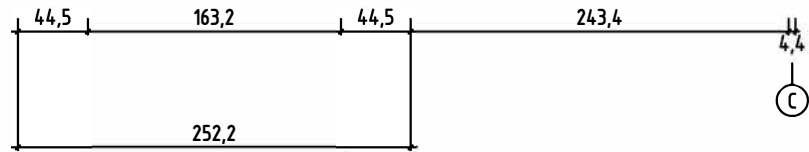



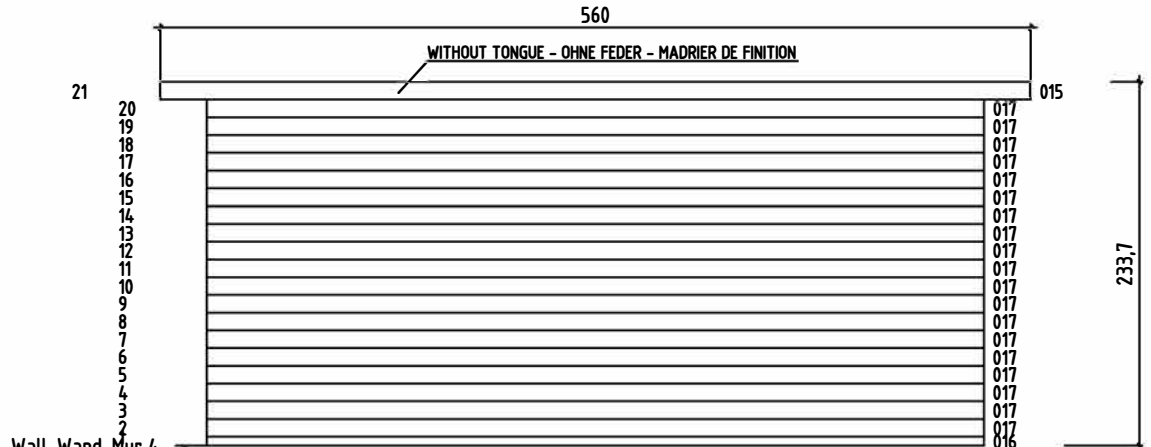
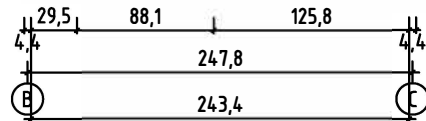



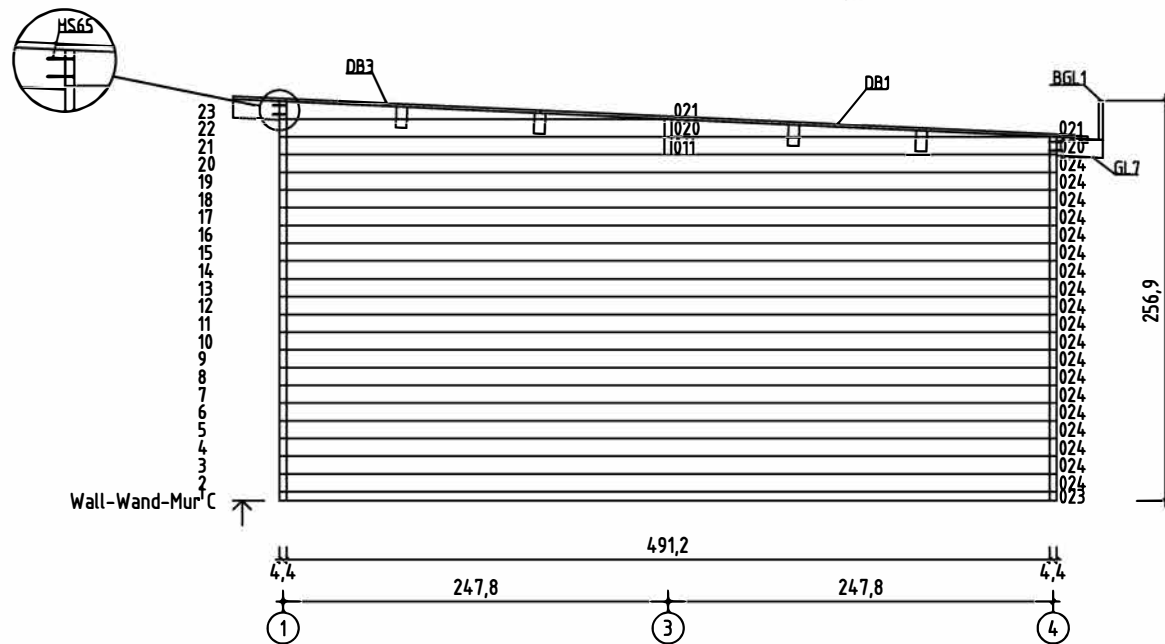
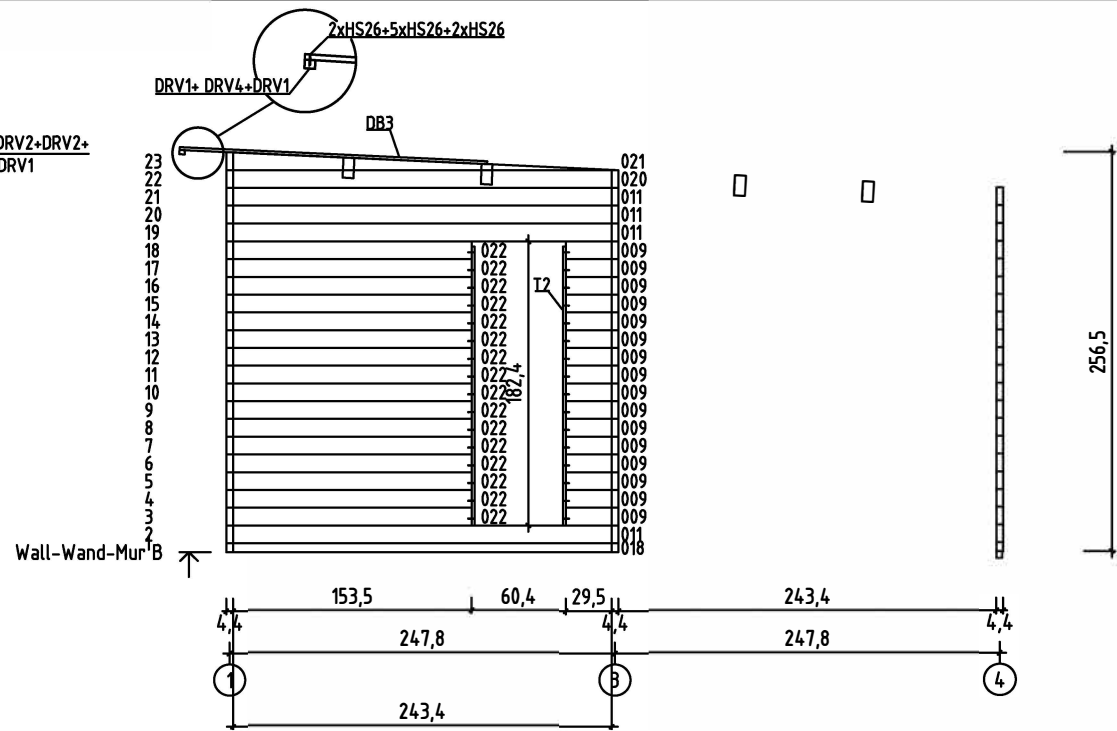
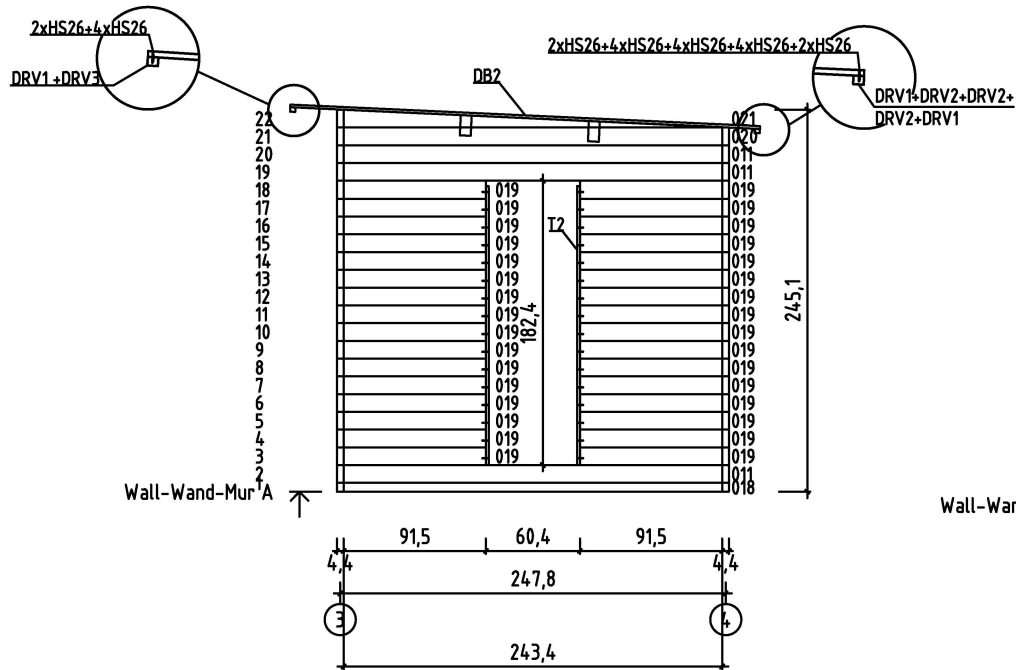























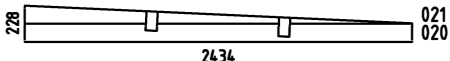
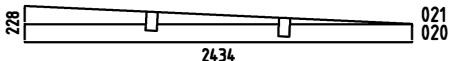
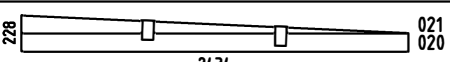

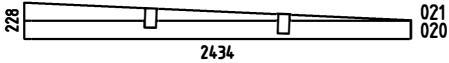

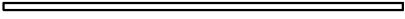









Wall-Wand-Mur 2

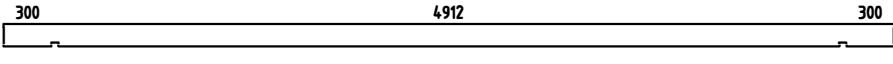
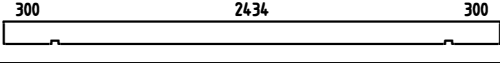



































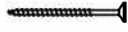
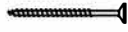
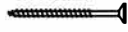
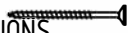

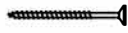
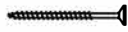
Wall-Wand-Mur 4

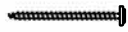

Pos	1.09.2016	Piece list - Stückliste - Liste des pièces	8/12	Q.	P (mm)	L (mm)
001				1	44x57	2522
002				17	44x114	2522
003				5	44x114	1493
004				39	44x114	445
005				1	44x114	3122
006				1	44x114	3122
007				1	44x57	295
008				1	44x57	1258
009				33	44x114	295
010				17	44x114	1258
011				12	44x114	2434
012				1	44x114	2434
013				2	44x57	445
014				1	44x114	5600
015				2	44x114	5600
016				1	44x57	5000
017				19	44x114	5000
018				2	44x57	2434
019				32	44x114	915
022				16	44x114	1535
023				1	44x57	4912
024				19	44x114	4912
WA-1				1		
WB-1				1		
WC-1				1		

Pos	1.09.2016	Piece list - Stückliste - Liste des pièces	9/12	Q.	P (mm)	L (mm)
WC-2				1		
IAR3		FOUNDATION - FUNDAMENT - FONDATION 		1	70x45	4990
IAR2		FOUNDATION - FUNDAMENT - FONDATION 		5	70x45	4850
IAR5		FOUNDATION - FUNDAMENT - FONDATION 		1	70x45	2512
IAR4		FOUNDATION - FUNDAMENT - FONDATION 		1	70x45	2478
IAR1		FOUNDATION - FUNDAMENT - FONDATION 		4	70x45	2372
KP3		ROOFING FELT FILLET - DACHPAPPENLEISTE - BAGUETTE DE FIXATION DU FEUTRE BITUMEUX 		1	58x18	5636
KP1		ROOFING FELT FILLET - DACHPAPPENLEISTE - BAGUETTE DE FIXATION DU FEUTRE BITUMEUX 		1	58x18	3158
KP5		ROOFING FELT FILLET - DACHPAPPENLEISTE - BAGUETTE DE FIXATION DU FEUTRE BITUMEUX 		1	58x18	3042
KP2		ROOFING FELT FILLET - DACHPAPPENLEISTE - BAGUETTE DE FIXATION DU FEUTRE BITUMEUX 		1	58x18	2536
KP4		ROOFING FELT FILLET - DACHPAPPENLEISTE - BAGUETTE DE FIXATION DU FEUTRE BITUMEUX 		1	58x18	2420
VL4		GABLE MOULDING - GIEBELLEISTE - PLANCHE DE RIVE 		3	18x120	5636
VL3		GABLE MOULDING - GIEBELLEISTE - PLANCHE DE RIVE 		3	18x120	5618
VL1		GABLE MOULDING - GIEBELLEISTE - PLANCHE DE RIVE 		6	18x120	3122
VL5		GABLE MOULDING - GIEBELLEISTE - PLANCHE DE RIVE 		3	18x120	2496
VL2		GABLE MOULDING - GIEBELLEISTE - PLANCHE DE RIVE 		3	18x120	2478
A.PR21		ROOF BEAM - DACHBALKEN - PANNE DE TOIT 		2	70x140	5600
A.PR22		ROOF BEAM - DACHBALKEN - PANNE DE TOIT 		2	70x140	3122
FB1		FLOOR BOARDS - FUSSBODENBRETTER - LAME DE PLANCHER 		27	90x18	4908
FB2		FLOOR BOARDS - FUSSBODENBRETTER - LAME DE PLANCHER 		28	90x18	2430
DB1		ROOF BOARDS - DACHBRETTER - VOLIGES 		35	90x18	3500
DB2		ROOF BOARDS - DACHBRETTER - VOLIGES 		28	90x18	3000
DB3		ROOF BOARDS - DACHBRETTER - VOLIGES 		35	90x18	1980
FL		FLOOR FILLET-FUSSBODENLEISTE - CORNIERE DE FINITION DU PLANCHER 			18x18	24.4
TBE1		CORNER FILLET - DECKLEISTE - PROFILS DE FINITION ANGLES A L'EXTERIEUR 		2	18x70	2337

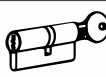
Pos	1.09.2016	Piece list - Stückliste - Liste des pièces	10/12	Q.	P (mm)	L (mm)
TBE2	CORNER FILLET - DECKLEISTE - PROFILS DE FINITION ANGLE RENTANT À L'INTÉRIEUR		1	18x70	2433	
TBE3	CORNER FILLET - DECKLEISTE - PROFILS DE FINITION ANGLES A L'EXTERIEUR		1	18x70	2451	
TBE4	CORNER FILLET - DECKLEISTE - PROFILS DE FINITION ANGLES A L'EXTERIEUR		2	18x70	2565	
TBE5	CORNER FILLET - DECKLEISTE - PROFILS DE FINITION ANGLE RENTANT À L'INTÉRIEUR		1	18x90	2205	
TBE6	CORNER FILLET - DECKLEISTE - PROFILS DE FINITION ANGLES A L'EXTERIEUR		3	18x90	2223	
TBE7	CORNER FILLET - DECKLEISTE - PROFILS DE FINITION ANGLES A L'EXTERIEUR		2	18x90	2337	
P1	CORNER STUD - ECKPFOSTEN - POTEaux D'ANGLE POUR FIXATION DES MADRIERS		2	44x44	2300	
P2	CORNER STUD - ECKPFOSTEN - POTEaux D'ANGLE POUR FIXATION DES MADRIERS		2	44x44	2400	
P3	CORNER STUD - ECKPFOSTEN - POTEaux D'ANGLE POUR FIXATION DES MADRIERS		4	44x44	2500	
DRV1	ROOF EDGE REINFORCEMENT - DACHRANDVERSTÄRKUNG - CORNIERE DE RENFORT DE BORD DE TOIT		5	28x34	370	
DRV2	ROOF EDGE REINFORCEMENT - DACHRANDVERSTÄRKUNG - CORNIERE DE RENFORT DE BORD DE TOIT		3	28x34	1561	
DRV3	ROOF EDGE REINFORCEMENT - DACHRANDVERSTÄRKUNG - CORNIERE DE RENFORT DE BORD DE TOIT		1	28x34	1916	
DRV4	ROOF EDGE REINFORCEMENT - DACHRANDVERSTÄRKUNG - CORNIERE DE RENFORT DE BORD DE TOIT		1	28x34	2226	
T1	FIXING FILLET - FIXIRUNGSLEISTE - PROFIL DE FIXATION POUR OUVERTURE DE FENÊTRE 54X54		2	18x44	540	
T2	FIXING FILLET - FIXIRUNGSLEISTE - PROFIL DE FIXATION POUR OUVERTURE DE FENÊTRE 56X178		4	18x44	1800	
T3	FIXING FILLET - FIXIRUNGSLEISTE - PROFIL DE FIXATION POUR OUVERTURE DES PORTES		4	18x44	1970	
GL7	DISTANCE SPACERS FOR GABLE MOULDING - DACHSTÜZEN - SUPPORTS EXTENSION TOITURE		8	44x120	305	
BGL2	FIXING SLAT FOR DISTANCE SPACERS - BEFESTIGUNGSLEISTE - RENFORTS PLANCHES DE RIVES		2	28x34	240	
BGL1	FIXING SLAT FOR DISTANCE SPACERS - BEFESTIGUNGSLEISTE - RENFORTS PLANCHES DE RIVES		6	28x34	350	
FS	WINDOW HANDLE FITTINGS - FENSTERGRIFF - POIGNÉE D'OUVERTURE DE FENETRE		3			
HS66	SCREW FOR CORNER FILLET - SCHRAUBE FÜR DECKLEISTEN - VIS DE FIXATION PROFILS DE FINITION ANGLES A L'EXTERIEUR		84	3.5x50		
	SCREW FOR DOOR FILLET - SCHRAUBE ZUR BEFESTIGUNG TÜRLEISTE - VIS D'ASSEMBLAGE DU CADRE DE PORTE		5	3x30		
HS79	SCREWS FOR WALL MOUNTING - SCHRAUBEN FÜR WANDMONTAGE - VIS DE FIXATION AU MUR		608	4.5x80		
HS32	SCREW FOR GABLE MOULDING - SCHRAUBEN FÜR GIEBELLEISTE - VIS DE FIXATION POUR PLANCHE DE RIVE		168	4x40		
HS26	SCREW FOR ROOF EDGE REINFORCEMENT - SCHRAUBEN FÜR DACHRANDVERSTÄRKUNG - VIS POUR RENFORT DE BORD DE TOIT		31	4x40		

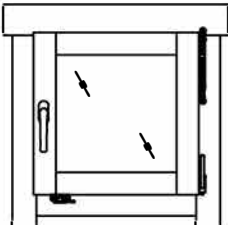
Pos	1.09.2016	Piece list - Stückliste - Liste des pièces	11/12	Q.	P (mm)	L (mm)
HS98		SCREW FOR FIXING FILLET OF DOOR AND WINDOW - SCHRAUBEN FÜR FIXIRUNGSLEISTE - VIS POUR PROFIL VERTICAL DE FIXATION POUR OUVERTURES DES FENÊTRES ET PORTES		146	4x40	
HS97		SCREW FOR DISTANCE SPACER FIXING SLAT - SCHRAUBEN FÜR BEFESTIGUNGS LEISTE - VIS DE FIXATION RENFORTS PLANCHES DE RIVES		16	4x40	
HS4		SCREW FOR ROOF BEAMS - SCHRAUBEN FÜR DACHBALKEN - VIS POUR PANNE DE TOIT		16	5x120	
HS2		SCREW FOR 1. WALL BEAM - SCHRAUBE FÜR 1. BOHLENREIHE - VIS DE FIXATIONS 1ère RANGÉE DE MADRIERS AVEC POUTRELLES DE FONDATIONS		27	5x90	
HS1		SCREW FOR FOUNDATION - SCHRAUBEN ZUR BEFISTIGUNG FUNDAMENT - VIS DE FIXATIONS DES POUTRELLES DE FONDATIONS		19	5x120	
HS65		SCREW FOR FIXING GABLE MOULDING DISTANCE SPACERS TO THE WALL - SCHRAUBEN FÜR DACHSTÜTZEN - VIS DE SUPPORTS EXTENSION TOITURE		16	5x90	
		SCREW FOR DOOR JAMB - SCHRAUBE FÜR TÜRRAHMEN - VIS DE FIXATION POUR MONTANT DE PORTE		4	5x90	
		ZN NAIL FOR FLOOR FILLET - ZN NÄGEL FÜR FUSSBODENLEISTE - POINTE POUR CORNIERE DE FINITION DU PLANCHER		49	1.4x40	
		HAMMER BLOCK - SCHLAGHOLZ - CALLE DE FRAPPE		1		
		SCREW FOR DOORSTEP - SCHRAUBEN FÜR TÜRSCHWELLE - VIS DE FIXATION DU SEUIL DE PORTE		5	4.5x65	
HS7		ZN NAIL FOR ROOFING FELT FILLET - ZN NAGEL FÜR DACHPAPPENLEISTE - POINTE POUR BAGUETTE FIXATION FEUTRE BITUMEUX		40	2x40	
HS5		ZN NAIL FOR ROOF - ZN NÄGEL FÜR DACHBRETTER - POINTE POUR TOIT		450	2x50	
HS3		ZN NAIL FOR FLOOR - ZN NÄGEL FÜR FUSSBODENBRETTER - CLOUS POUR PLANCHER		400	2x50	
		DOOR HANDLE FITTINGS-TÜRGRIF - SET DE GARNITURES DE SERRURE DE PORTE		2		
		SET OF DOOR LOCK COVERS - SCHLOSSBLENDEN - SET DE GARNITURES DE SERRURE DE PORTE		2		
		MALE BOLT HINGE FOR DOOR - TÜRRIEGEL - PARTIE MALE DE CHARNIERE DE PORTE		6	14x80	
		CYLINDER LOCK - ZYLINDERSCHLOSS - CYLINDRE DE SERRURE		2	30x35	
		STRIKER FOR BARREL BOLT - HÜLSE FÜR GRENDDELRIEGEL - GACHE AU SOL DU TARGETTE		2		
		WINDOW - FENSTER - FENETRE 540x540	AK.1.100.PSP.a	DGP+	1	
						

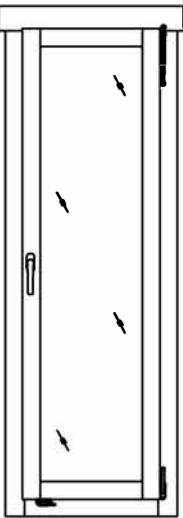
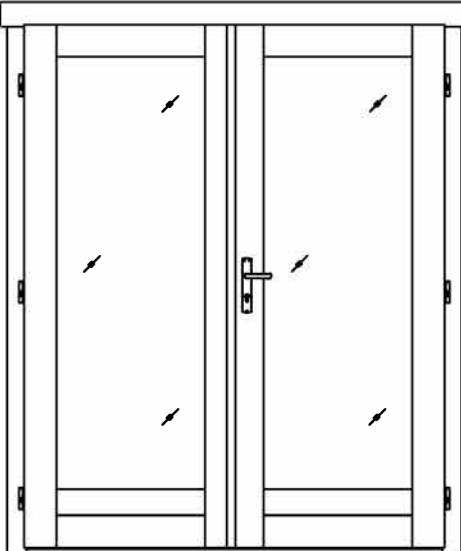
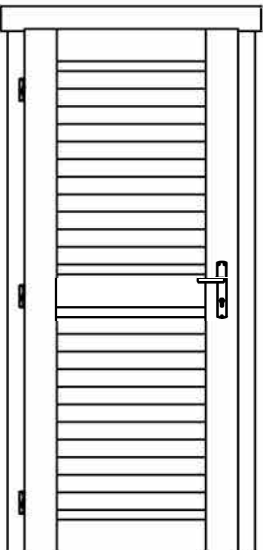
Pos	1.09.2016 Piece list - Stückliste - Liste des pièces	12/12	Q.	P (mm)	L (mm)
	<p data-bbox="247 145 710 179">WINDOW - FENSTER - FENETRE 560x1780</p> <p data-bbox="821 145 965 179">AK.1.100.PSP</p> <p data-bbox="1141 145 1212 179">DGP+</p> 	2			
	<p data-bbox="247 817 598 851">DOOR- TÜR - PORTE 1588x1957</p> <p data-bbox="821 817 1021 851">TUK.1100.PVP.MM</p> <p data-bbox="1141 817 1212 851">DGP+</p> 	1			
	<p data-bbox="247 1512 598 1545">DOOR - TÜR - PORTE 835x1957</p> <p data-bbox="821 1512 1005 1545">UL.2.100.IVV.MM</p> <p data-bbox="1141 1512 1204 1545">TP+</p> 	1			

1. Foundation/Fundament/Fondation

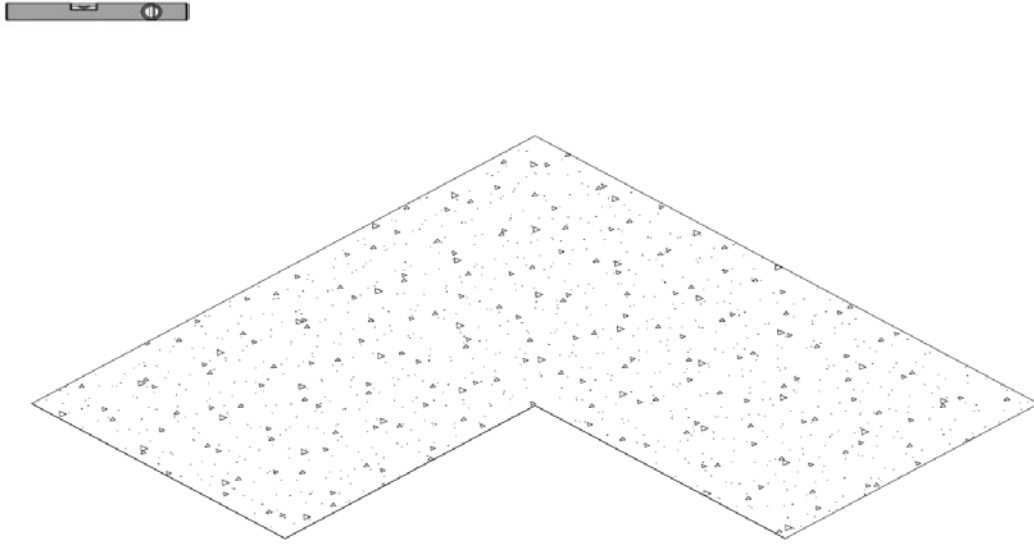

2. Preparation of components/Vorbereitung der Einzelteile/Préparation des composants

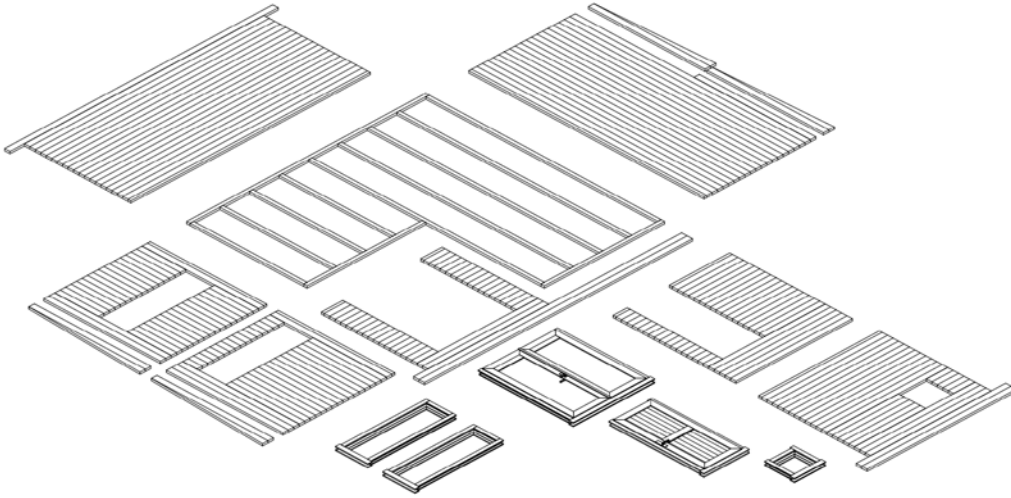

3. Base internal frame (foundation joists)/Fundamentbalken/Poutrelles de fondation

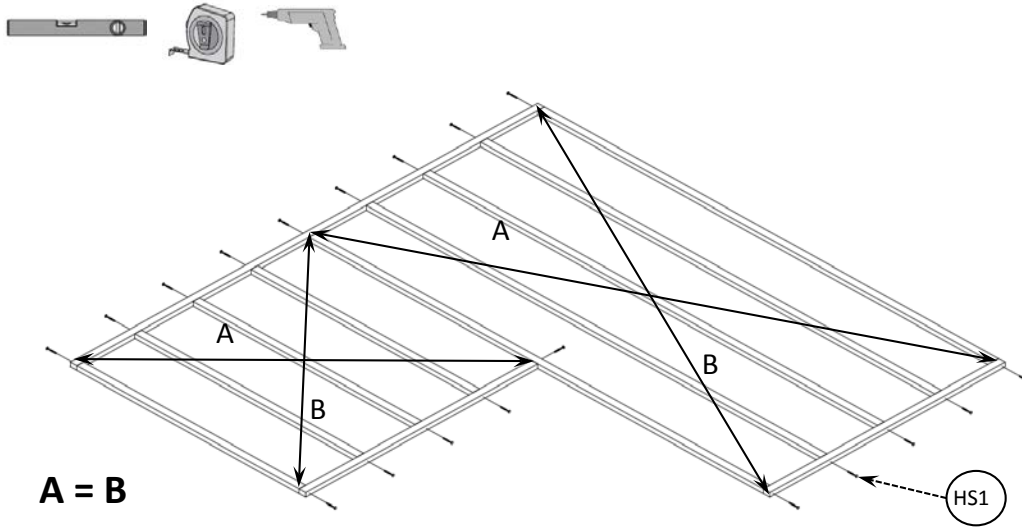

Screw/Schrauben/Vis 5x120mm (HS1)

4. 1. layer of wall/1. Bohlenreihe/1er rang de madriers

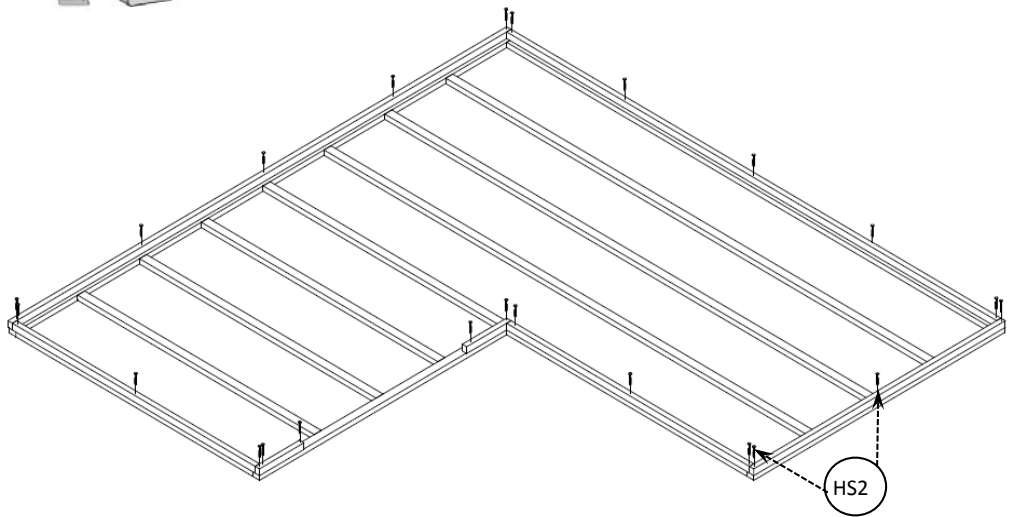

Screw/Schrauben/Vis 5x90 (HS2)

5. Floor/Fussboden/Plancher

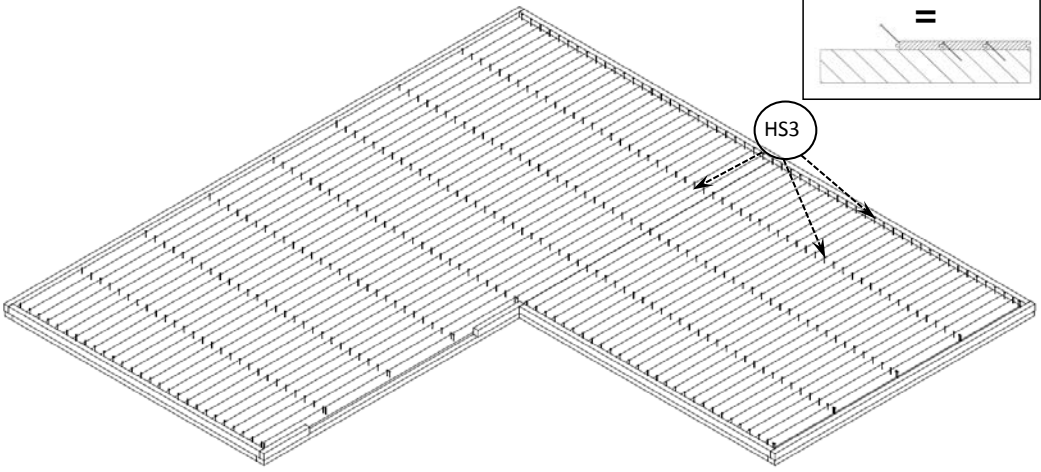

Nail/Nägel/Clous 2x50 (HS3)

6. Corner studs/Eckpfosten/Poteaux d'angle

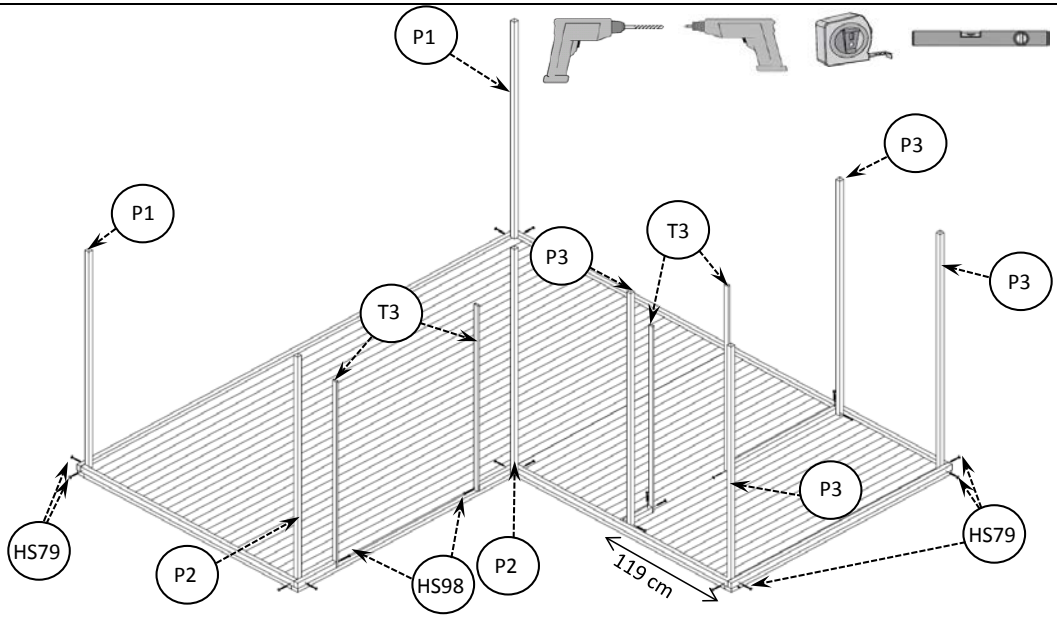

Screw/Schrauben/Vis 4.5x80 (HS79)
Screw/Schrauben/Vis 4x40 (HS98)

7. Wall/Wandmontage/Assemblage des murs

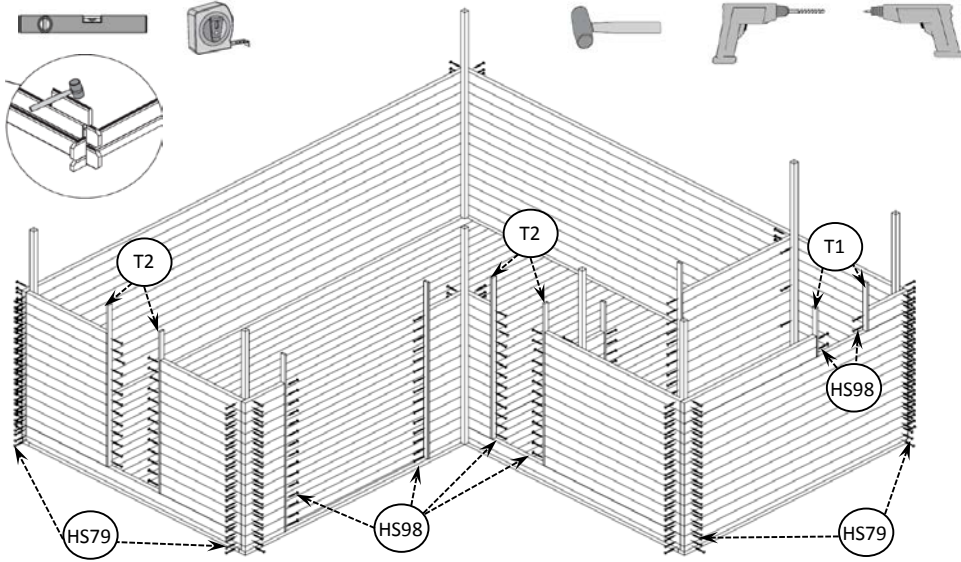

Screw/Schrauben/Vis 4.5x80 (HS79)
Screw/Schrauben/Vis 4x40 (HS98)

8. Door and window/Tür und Fenster/ Mise en place des ouvertures

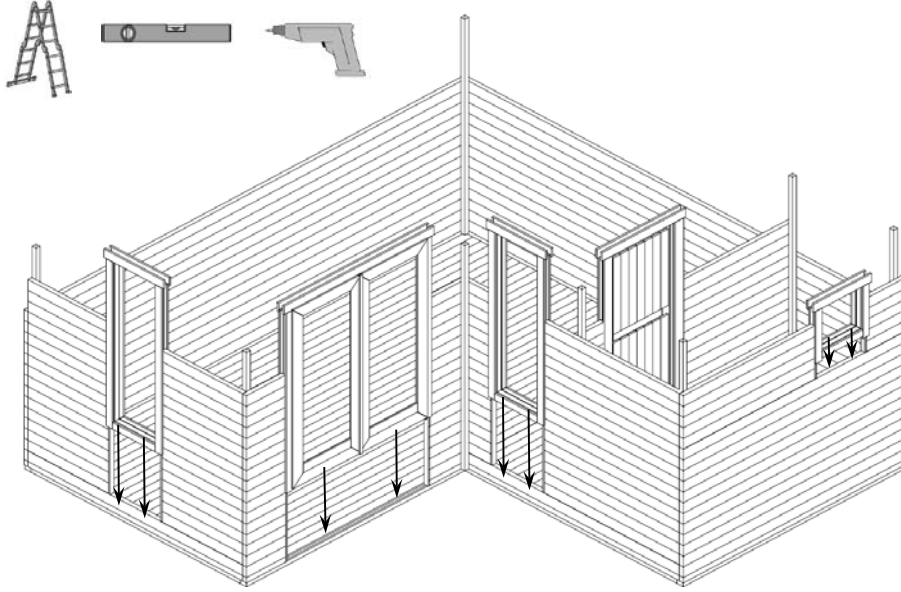

9. Corner cover fillets/Deckleisten/Profils de finitions des angles

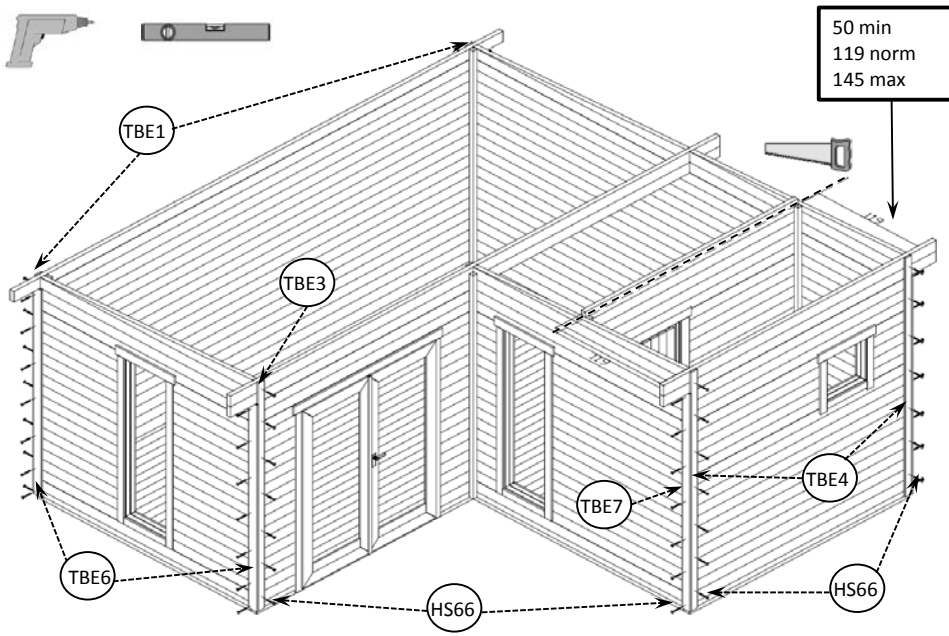

Screw/Schrauben/Vis 3.5x50 (HS66)

Roof beam/Dachbalken/Panne de toit

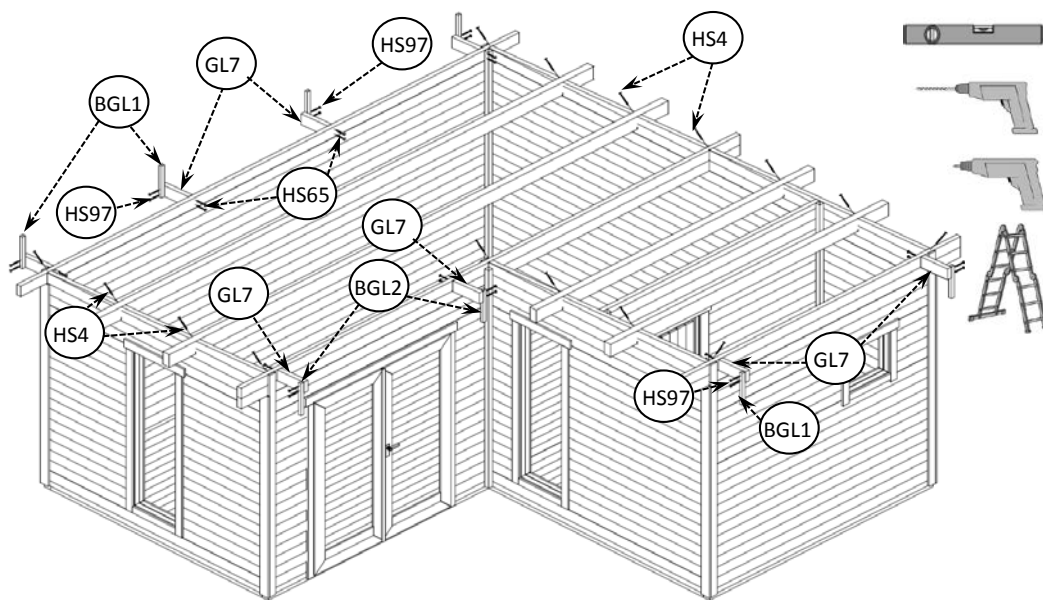

Screw/Schrauben/Vis 5x120 (HS4)
Screw/Schraube/Vis 5x90 (H65)
Screw/Schrauben/Vis 4x40 (HS97)

11. Roof boards/ Dachbretter/Voiges de toit

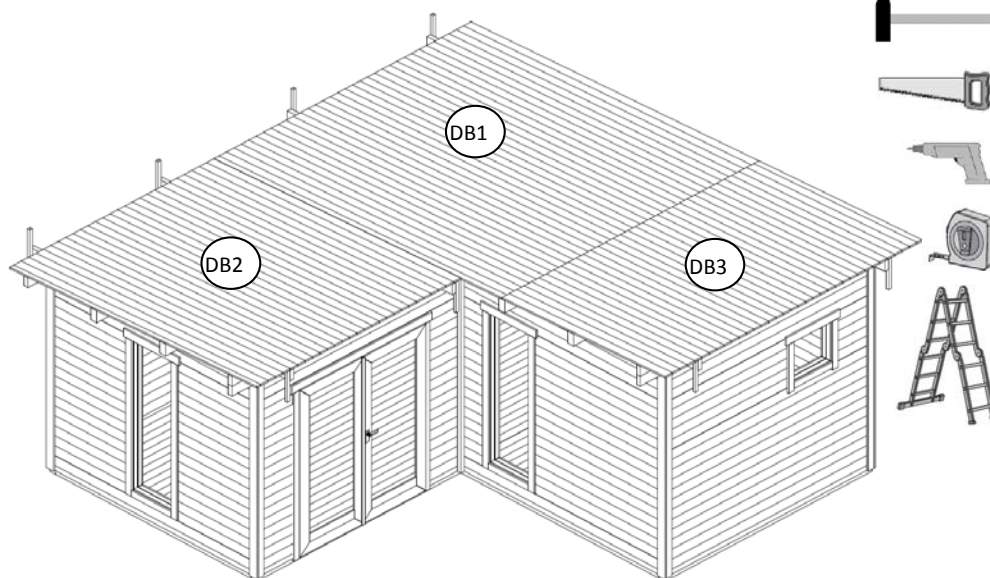

Nail/Nägels/Clous 2x50mm (HS5)

12. Gable moulding/ Giebelleiste/Planche de rive

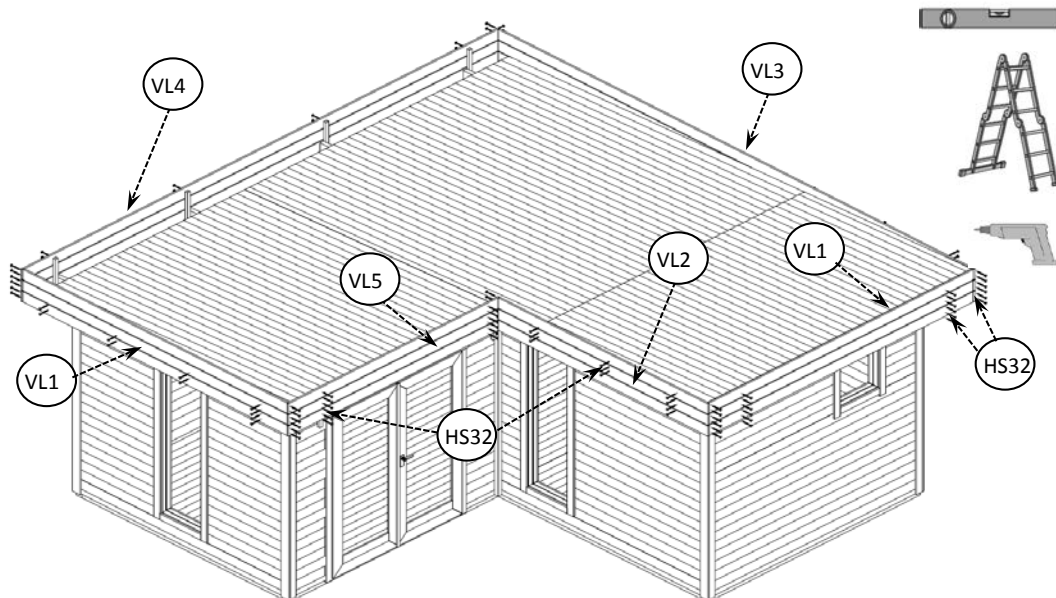

Screw/Schrauben/Vis 4x40 (HS32)

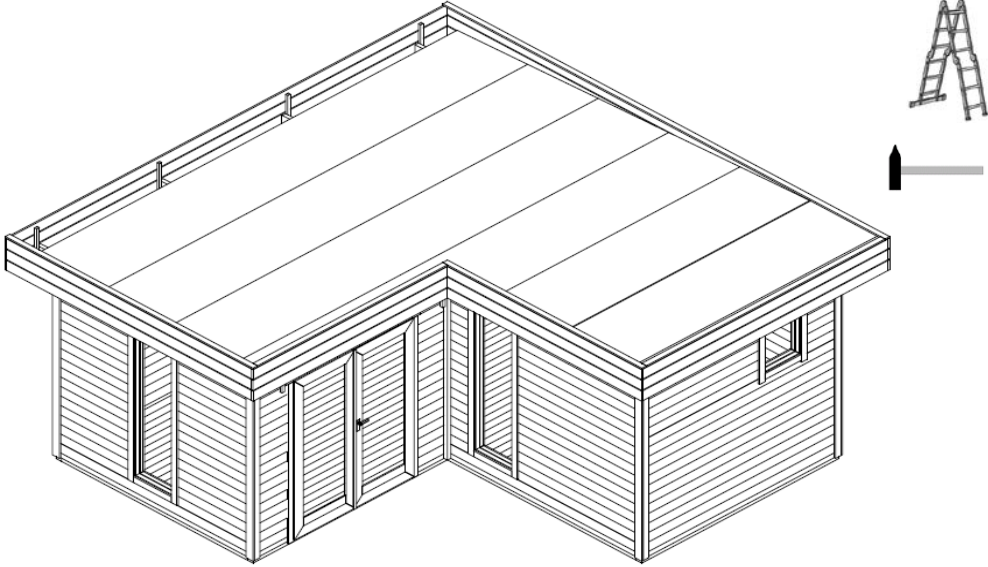
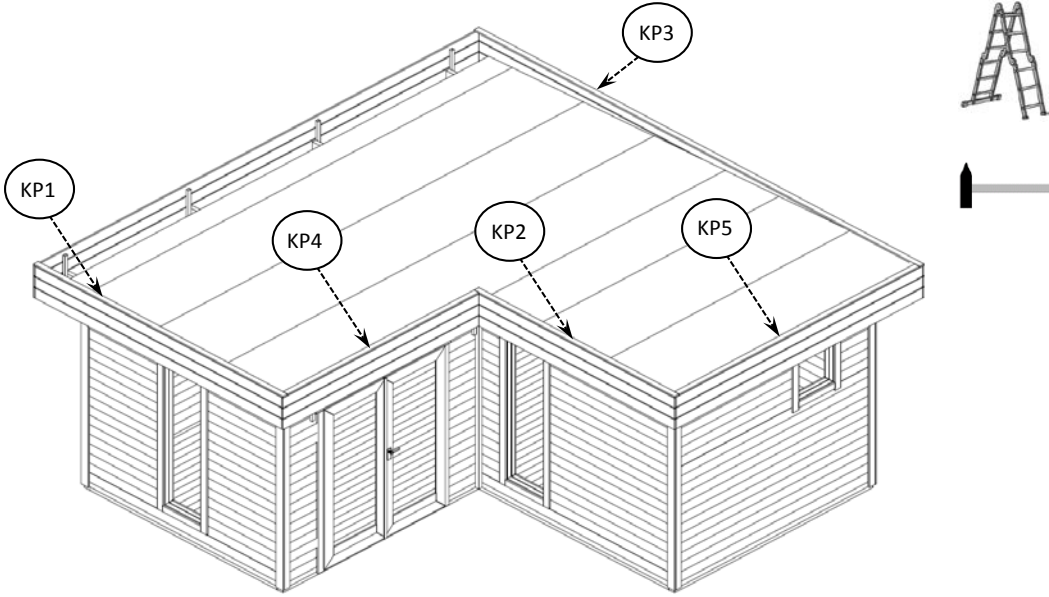
<p>13. Roofing felt (not included)/Dachpappe (nicht inklusive)/Feutre bitumeux (non inclus)</p>		<p>Nail /Nägel/Clous 2.8x15 (HS6)</p>
<p>14. Roofing felt fillet/Dachpappenleiste/Baguette de fixation du feutre bitumeux</p>		<p>Nail/nagel/Clous 2x40 (HS7)</p>