

*Kjell C*  
1/7

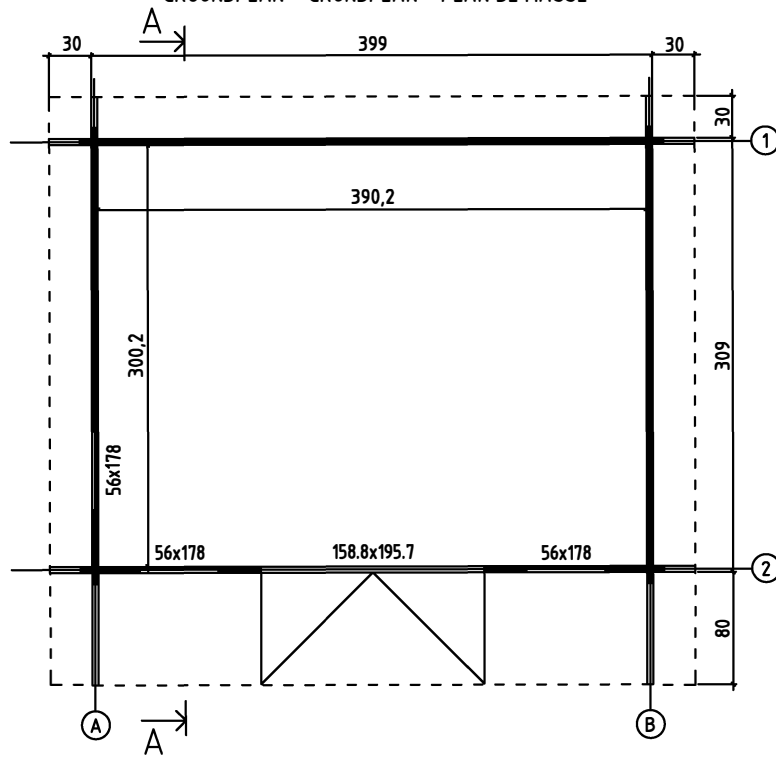

9.06.2016

GROUNDPLAN - GRUNDPLAN - PLAN DE MASSE



FOUNDATION - FUNDAMENT - FONDATION

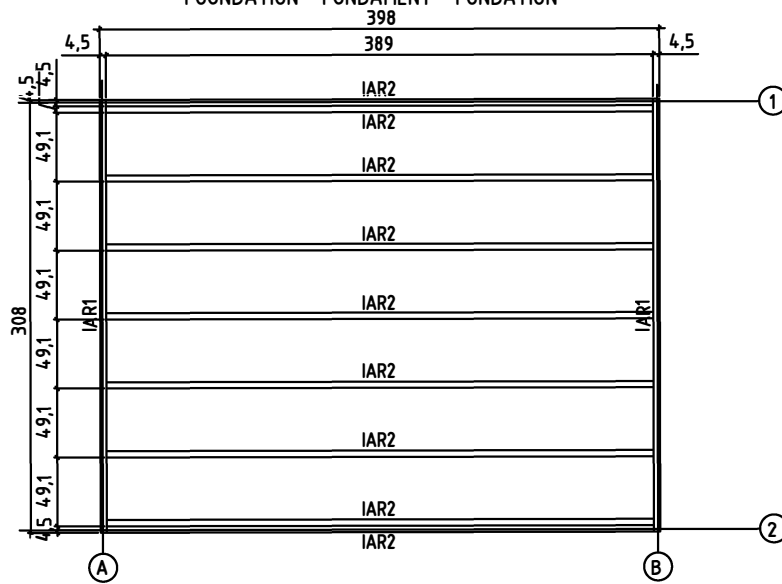



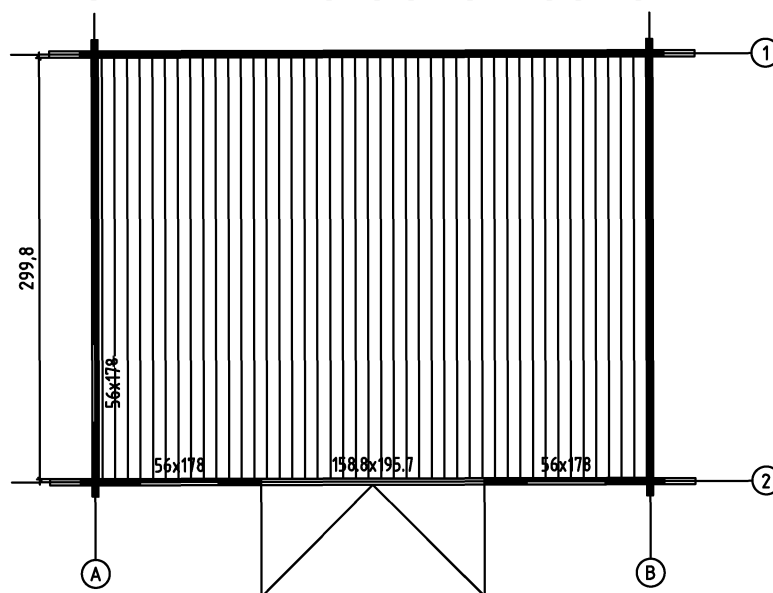

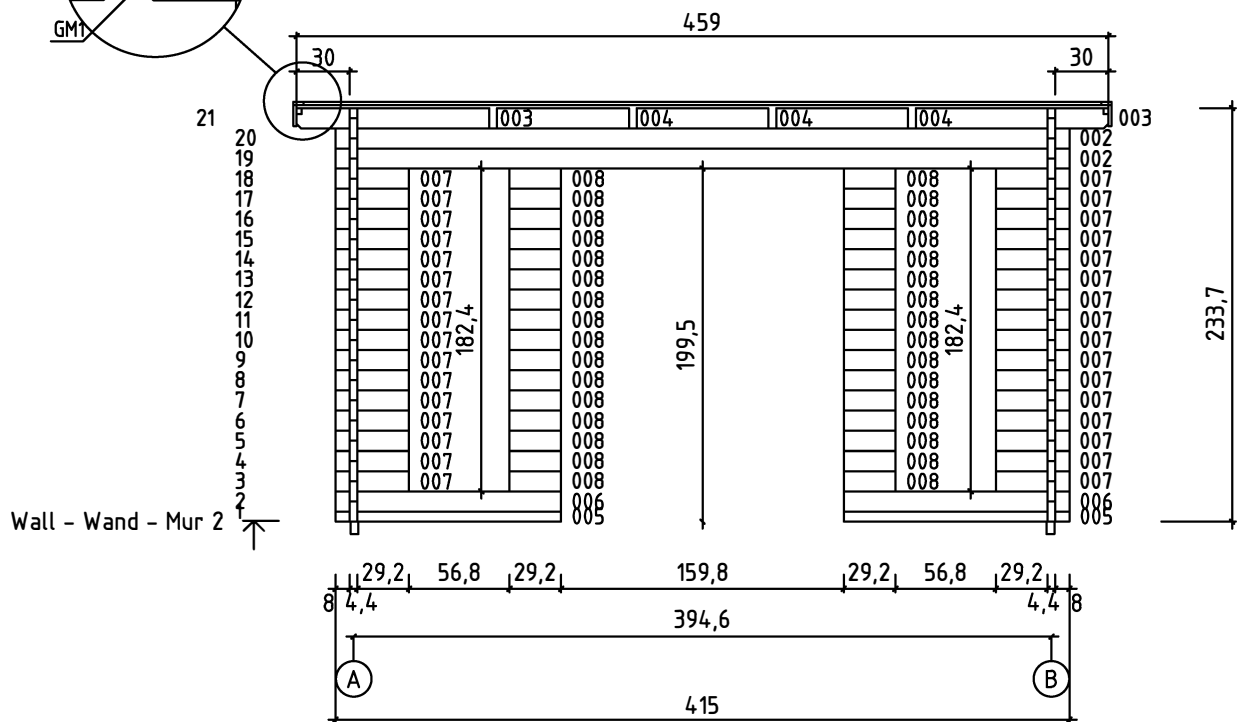
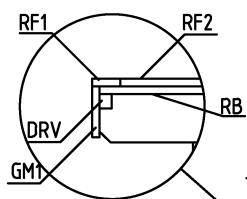
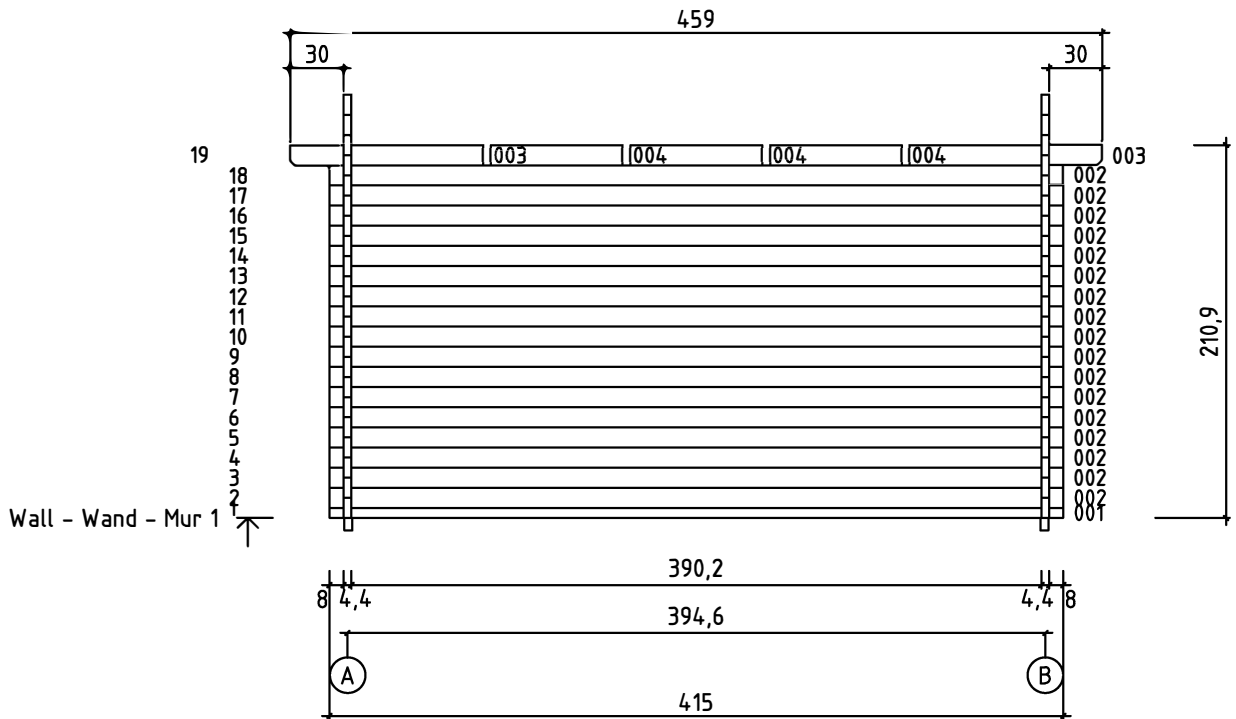

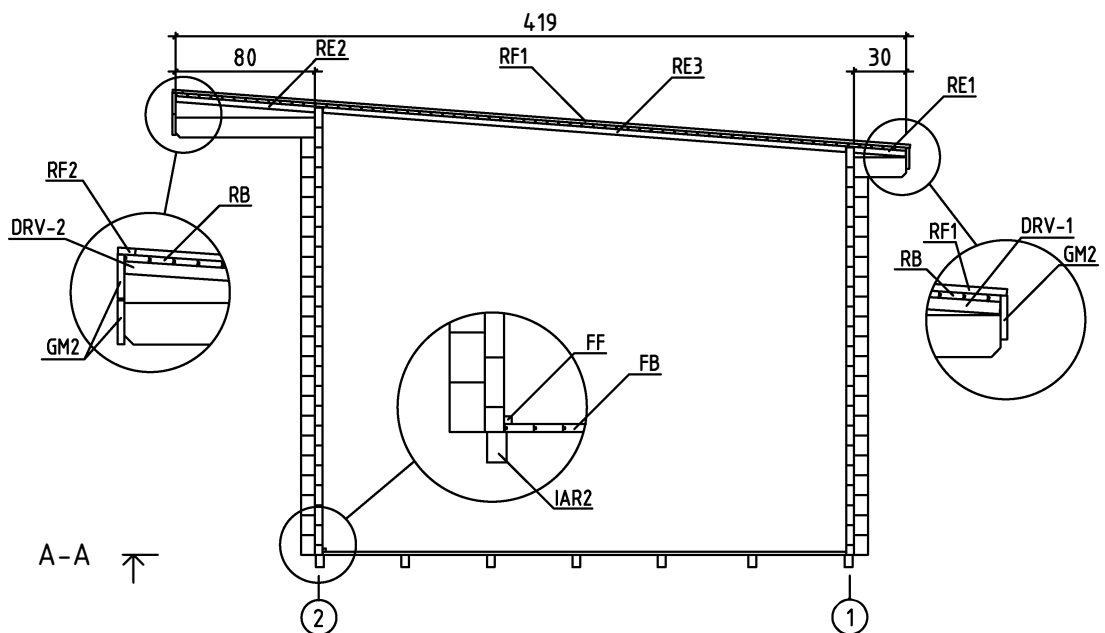
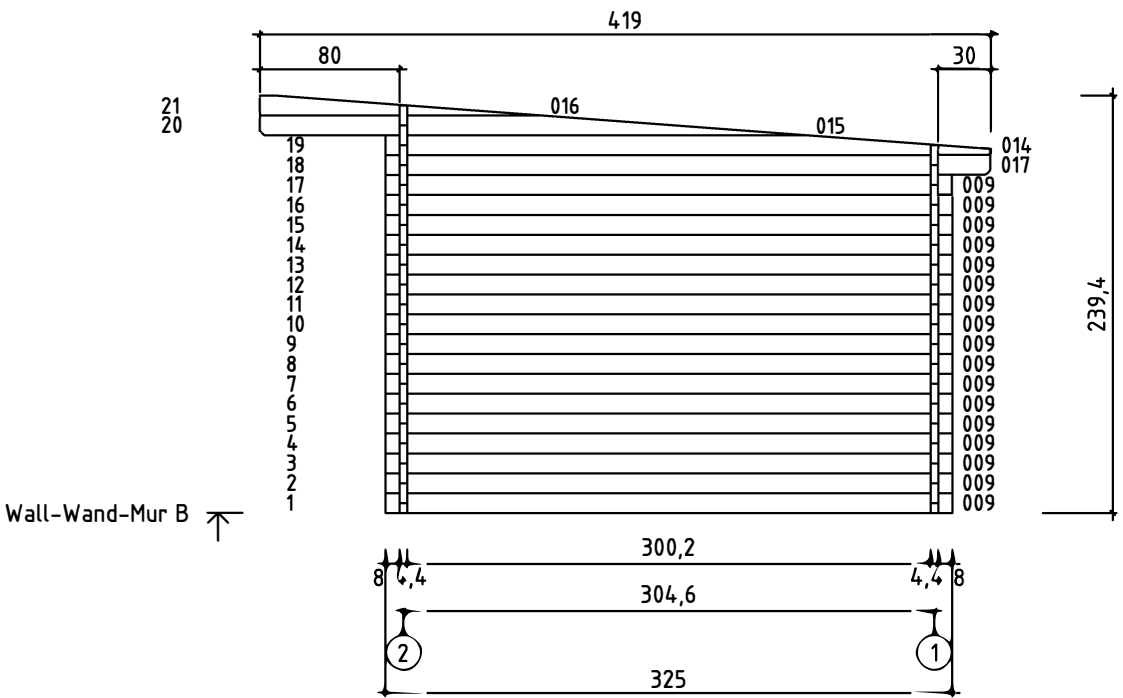
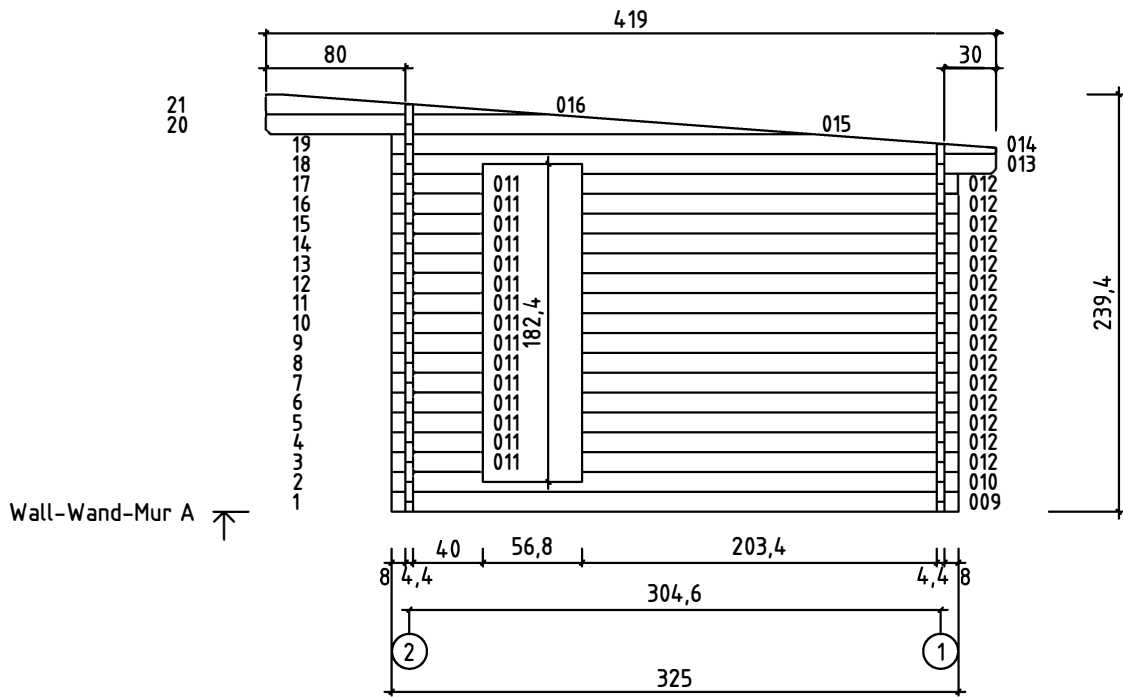

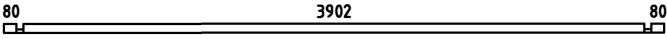
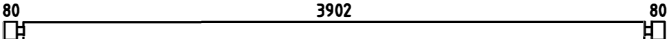
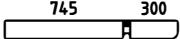
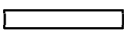
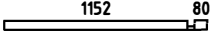
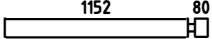

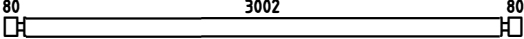
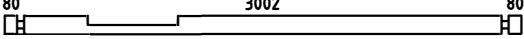

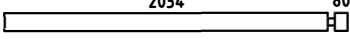
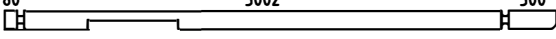
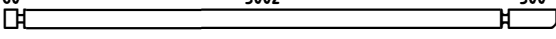
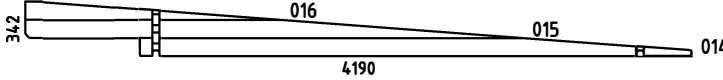
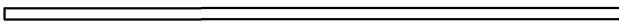
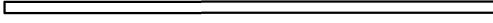
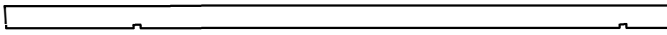

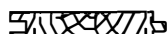







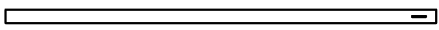
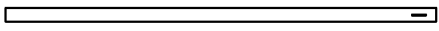
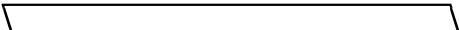
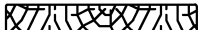
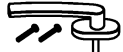



FLOOR BOARDS - FUSSBODENBRETTER - PLAN POSE PLANCHER

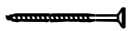



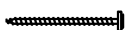
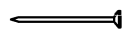
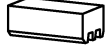
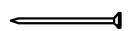

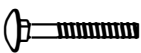

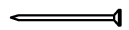
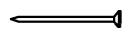

Pos	09.06.2016	Piece list - Stückliste - Liste des pièces	5/7	Q.	P (mm)	L (mm)
001				1	44x57	4150
002				19	44x114	4150
003				4	44x114	1089
004				6	44x114	745
005				2	44x57	1276
006				2	44x114	1276
007				32	44x114	416
008				32	44x114	292
009				18	44x114	3250
010				1	44x114	3250
011				15	44x114	524
012				15	44x114	2158
013				1	44x114	3470
017				1	44x114	3470
WA-1				1		
WB-1				1		
IAR2		FOUNDATION - FUNDAMENT - FONDATION 		9	45x70	3890
IAR1		FOUNDATION - FUNDAMENT - FONDATION 		2	45x70	3080
SR1		ROOF BEAM - DACHBALKEN - PANNE DE TOIT 		4	44x140	4212
FB		FLOOR BOARDS - FUSSBODENBRETTER - LAME DE PLANCHER 		44	90x18	2998
RB		ROOF BOARDS - DACHBRETTER - VOLIGES 		47	90x18	4590
FF		FLOOR FILLET-FUSSBODENLEISTE - CORNIERE DE FINITION DU PLANCHER 			18x18	13.79
RF1		ROOFING FELT FILLET - DACHPAPPENLEISTE - BAGUETTE DE FIXATION DU FEUTRE BITUMEUX 		2	18x58	4238
RF2		ROOFING FELT FILLET - DACHPAPPENLEISTE - BAGUETTE DE FIXATION DU FEUTRE BITUMEUX 		1	18x58	4510
DRV-1		ROOF EDGE REINFORCEMENT - DACHRANDVERSTÄRKUNG - CORNIERE DE RENFORT DE BORD DE TOIT 		2	28x34	300

Pos	09.06.2016	Piece list - Stückliste - Liste des pièces	6/7	Q.	P (mm)	L (mm)
DRV-2	ROOF EDGE REINFORCEMENT - DACHRANDVERSTÄRKUNG - CORNIERE DE RENFORT DE BORD DE TOIT			2	28x34	800
DRV-3	ROOF EDGE REINFORCEMENT - DACHRANDVERSTÄRKUNG - CORNIERE DE RENFORT DE BORD DE TOIT			2	28x34	3005
KFS-1	STORM PROTECTION - STURMLEISTE - LATTE ANTI-TEMPETE			2	22x45	2050
KFS-2	STORM PROTECTION - STURMLEISTE - LATTE ANTI-TEMPETE			2	22x45	2500
GM1	GABLE MOULDING - GIEBELLEISTE - PLANCHE DE RIVE			2	18x120	4212
GM2	GABLE MOULDING - GIEBELLEISTE - PLANCHE DE RIVE			3	18x120	4626
FS2	WINDOW HANDLE FITTINGS-FENSTERGRIFF - POIGNÉE D'OUVERTURE DE FENETRE			3	FG10.AL	
HS9	SCREW FOR GABLE MOULDING - SCHRAUBEN FÜR GIEBELLEISTE - VIS DE FIXATION POUR PLANCHE DE RIVE			60	3.5x50	
HS4	SCREW FOR FILLET - SCHRAUBE ZUR BEFESTIGUNG TÜRLEISTE - VIS D'ASSEMBLAGE DU CADRE DE PORTE			5	3x30	
HS12	SCREW FOR ROOF EDGE REINFORCEMENT - SCHRAUBEN FÜR DACHRANDVERSTÄRKUNG - VIS POUR RENFORT DE BORD DE TOIT			22	4x40	
HS18	SCREW FOR ROOF BEAMS - SCHRAUBEN FÜR DACHBALKEN - VIS POUR PANNE DE TOIT			12	5x120	
HS18	SCREW FOR GABLE - SCHRAUBEN FÜR GIEBEL - VIS POUR FIXATION DES PIGNONS			6	5x120	
HS23	SCREW FOR Pos. 004, 005 - SCHRAUBEN FÜR für Pos. 004, 005 VIS POUR FIXATION DERNIÈRE RANGÉE MADRIERS (MURS AVANT ET ARRIÈRE)			10	6x180	
HS16	SCREW FOR 1. WALL BEAM - SCHRAUBE FÜR 1. BOHLENREIHE - VIS DE FIXATION DES FONDATIONS			8	5x90	
HS16	SCREW FOR FUNDAMENT - SCHRAUBEN ZUR BEFESTIGUNG FUNDAMENT - VIS POUR FONDATION			22	5x90	
HS16	SCREW FOR DOOR JAMB - SCHRAUBE FÜR TÜRRAHMEN - VIS DE FIXATION POUR MONTANT DE PORTE			4	5x90	
HS25	SCREW FOR DOORSTEP - SCHRAUBEN FÜR TÜRSWELLE - VIS DE FIXATION DU SEUIL DE PORTE			3	4.5x65	
NF2	ZN NAIL FOR FLOOR FILLET - ZN NÄGEL FÜR FUSSBODENLEISTE - POINTE POUR CORNIERE DE FINITION DU PLANCHER			28	1.4x40	
SH44	HAMMER BLOCK - SCHLAGHOLZ - CALLE DE FRAPPE			1		
NF5	ZN NAIL FOR ROOFING FELT FILLET - ZN NÄGEL FÜR DACHPAPPENLEISTE - POINTE POUR BAGUETTE FIXATION FEUTRE BITUMEUX			28	2x40	
SFS	NUT FOR STORM PROTECTION - SCHRAUBENMUTTER FÜR STURMLEISTE - ÉCROU POUR LAME ANTI-TEMPETE			8	D8	
BFS	BOLT FOR STORM PROTECTION - BOLZEN FÜR STURMLEISTE - VIS POUR LAME ANTI-TEMPETE			8	8x80	
DFS	WASHER FOR STORM PROTECTION - DICHTSCHEIBE FÜR STURMLEISTE - RONDELLE POUR LAME ANTI-TEMPETE			8	D8	
NF4	ZN NAIL FOR ROOF - ZN NÄGEL FÜR DACHBRETTER - POINTE POUR TOIT			300	2x50	
NF4	ZN NAIL FOR FLOOR - ZN NÄGEL FÜR FUSSBODENBRETTER - CLOUS POUR PLANCHER			315	2x50	

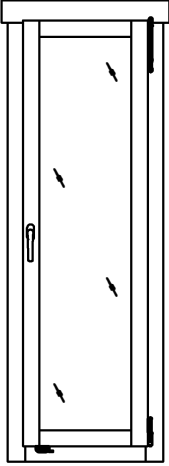
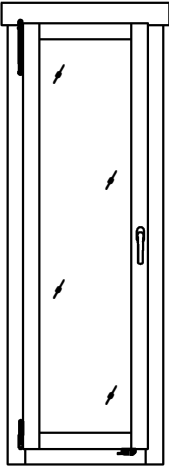
Pos	09.06.2016	Piece list - Stückliste - Liste des pièces	7/7	Q.	P (mm)	L (mm)
		MALE BOLT HINGE FOR DOOR - TÜRRIEGEL - PARTIE MALE DE CHARNIERE DE PORTE		6		
TL4		DOOR HANDLE FITTINGS-TÜRGRIF - SET DE GARNITURES DE SERRURE DE PORTE		1		
TL5		SET OF DOOR LOCK COVERS - SCHLOSSBLENDEN - SET DE GARNITURES DE SERRURE DE PORTE		1		
		CYLINDER - ZYLINDERSCHLOSS - CYLINDRE DE SERRURE		1	30x35	
		WINDOW - FENSTER - FENETRE 560x1780 DGP+	AK.1.100.PSP	2		
						
		WINDOW - FENSTER - FENETRE 560x1780 DGP+	AK.1.100.PSV	1		
						
		DOOR - TÜR - PORTE 1588x1957 DGP+	TUK.1.100.PVP.MM	1		
		