

| | | | | |
|-------------------|-------------------|----------|------------|------------|
| Name | Nora F 320x320/40 | | | |
| Zeichnung/Drawing | 3D | | | |
| Blatt/Sheet | Profil/Profile | 4.0x11.4 | Datum/Date | 05.06.2017 |

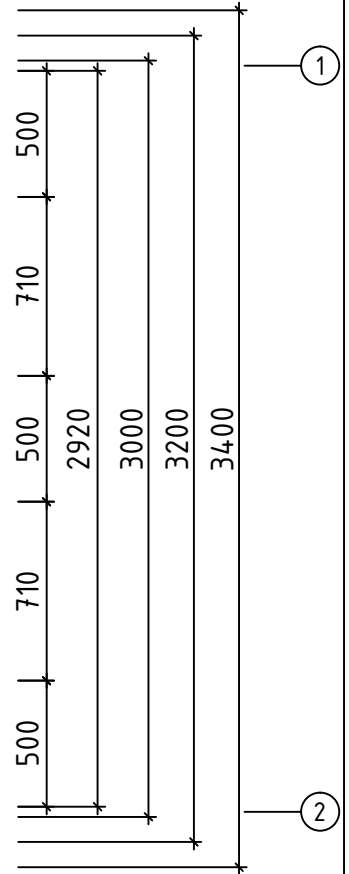

| | | | |
|-------------------|-------------------|----------|-----------------------|
| Name | Nora F 320x320/40 | | |
| Zeichnung/Drawing | Grundplan;Plan | | |
| Blatt/Sheet | Profil/Profile | 4.0x11.4 | Datum/Date 05.06.2017 |

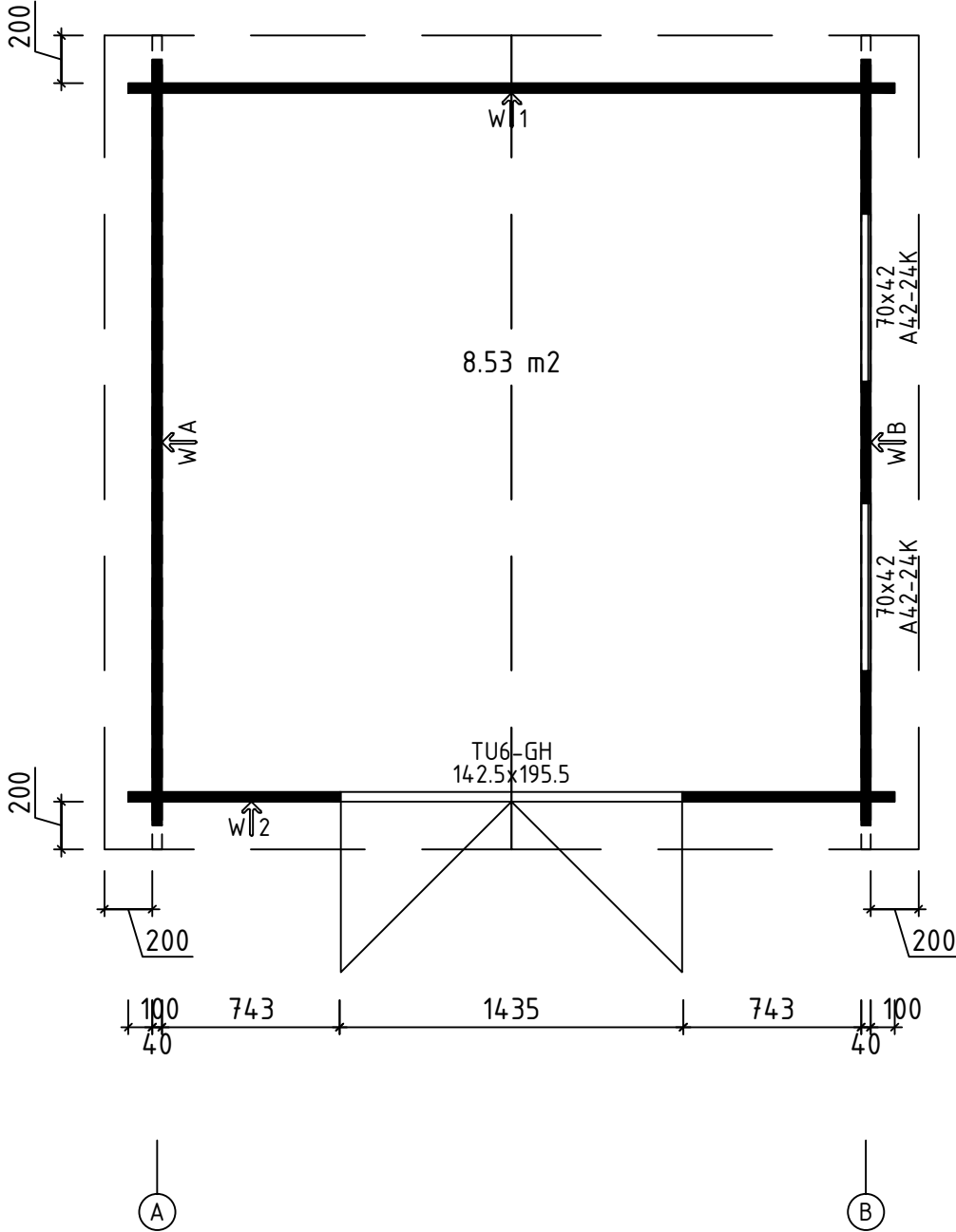
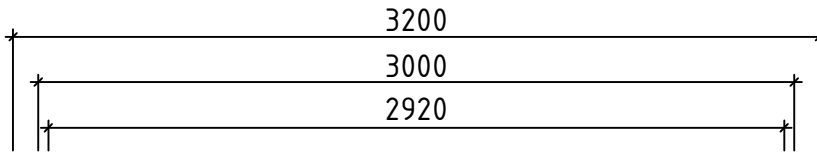
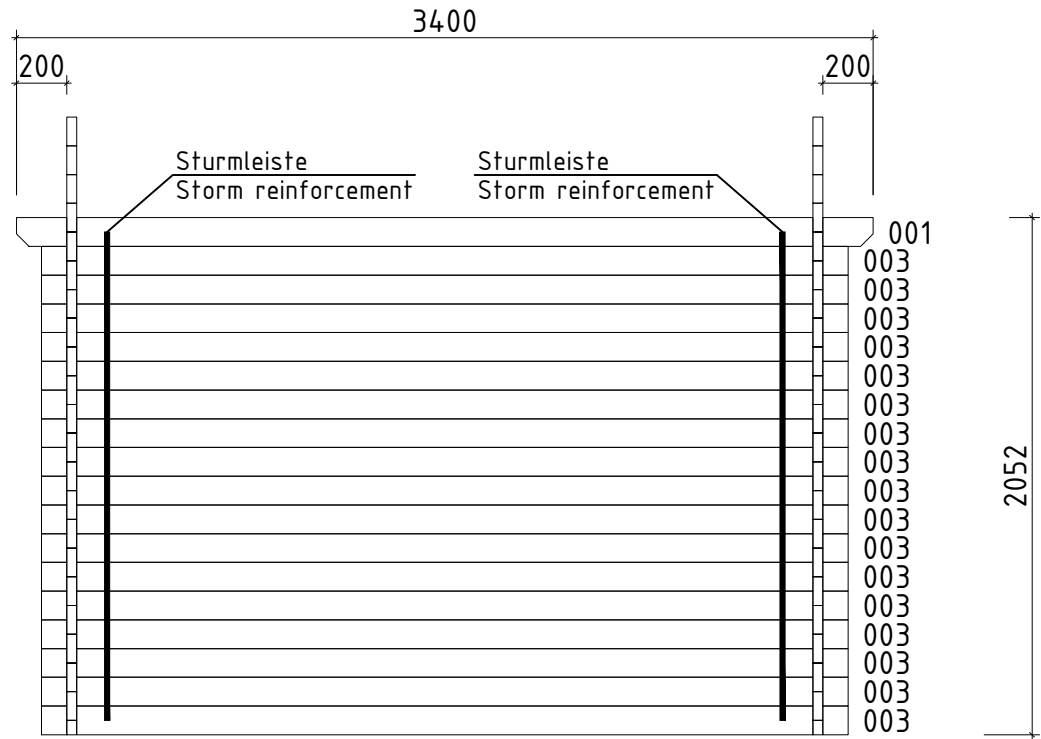
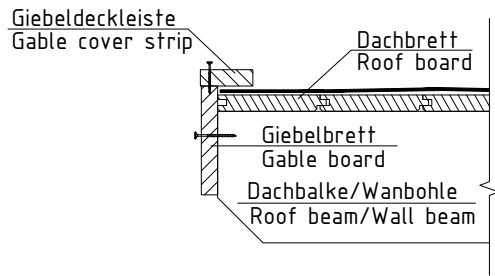

Wand/Wall A ↗

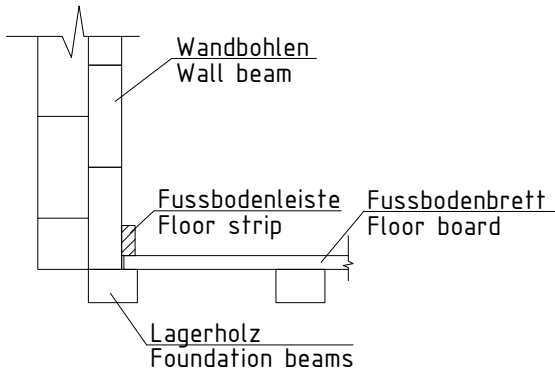
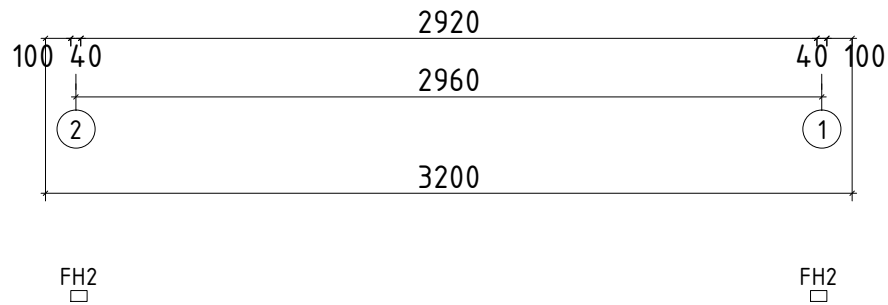

| | | | |
|-------------------|---|-------------------|------------|
| Name | | Nora F 320x320/40 | |
| Zeichnung/Drawing | | WAND/WALL A | |
| Blatt/Sheet | 2 | Profil/Profile | 4.0x11.4 |
| | | Datum/Date | 05.06.2017 |

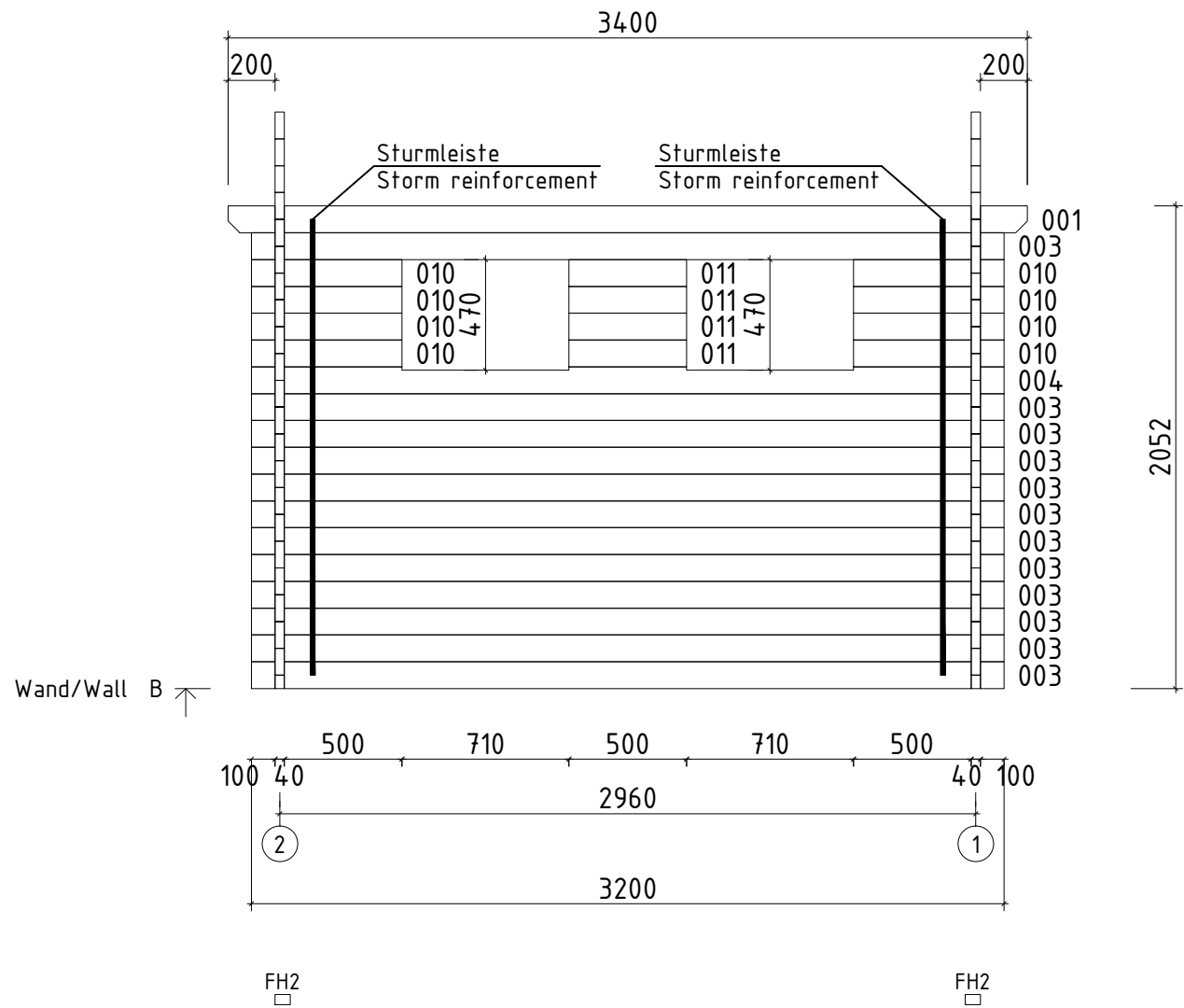

| | | | |
|-------------------|---|-------------------|------------|
| Name | | Nora F 320x320/40 | |
| Zeichnung/Drawing | | WAND/WALL B | |
| Blatt/Sheet | 3 | Profil/Profile | 4.0x11.4 |
| | | Datum/Date | 05.06.2017 |

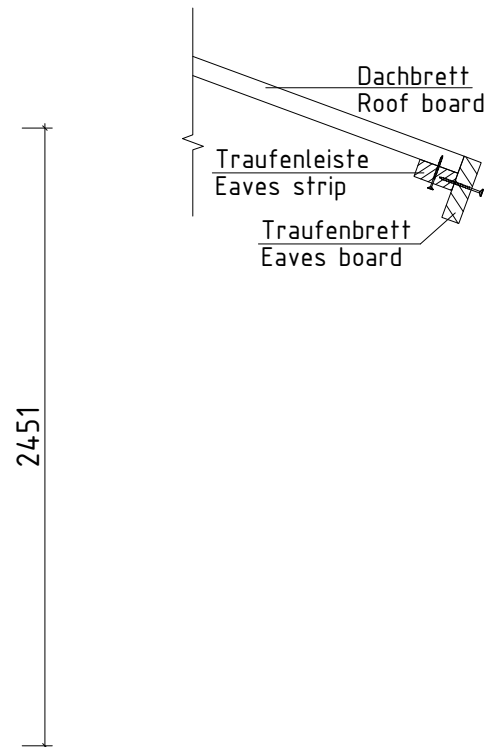
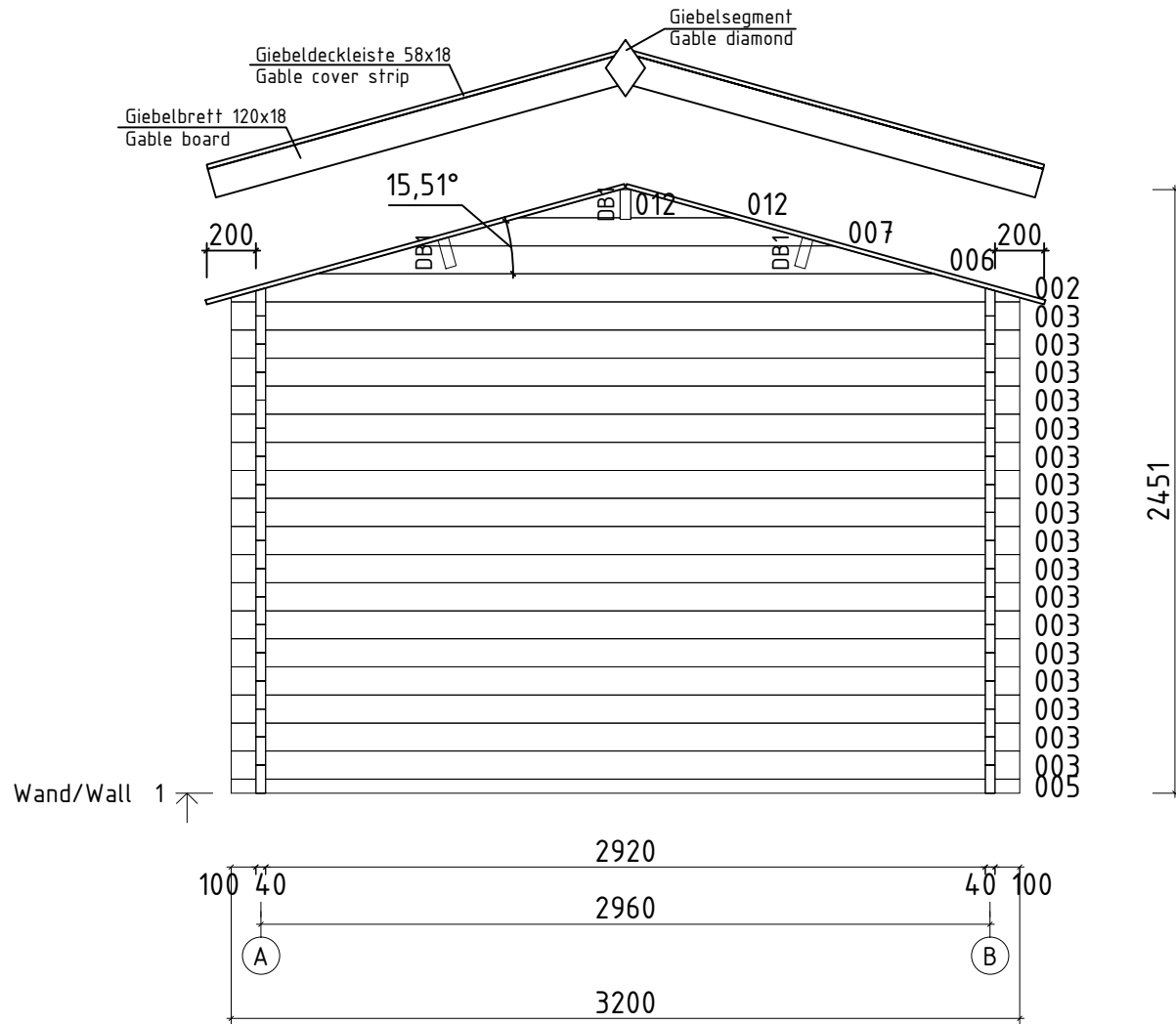

| | | | |
|-------------------|---|-------------------|------------|
| Name | | Nora F 320x320/40 | |
| Zeichnung/Drawing | | WAND/WALL 1 | |
| Blatt/Sheet | 4 | Profil/Profile | 4.0x11.4 |
| | | Datum/Date | 05.06.2017 |

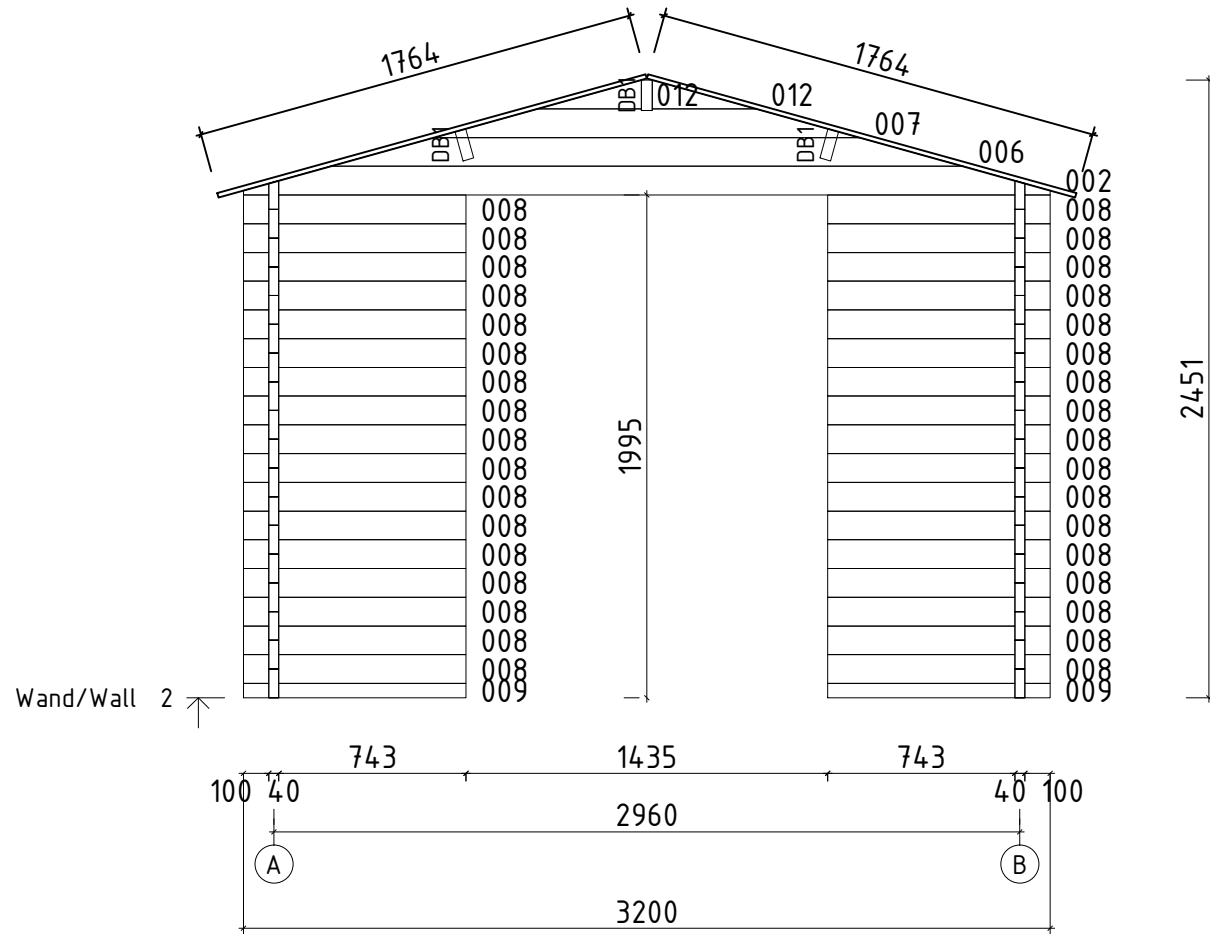

| | | | |
|-------------------|---|-------------------|------------|
| Name | | Nora F 320x320/40 | |
| Zeichnung/Drawing | | WAND/WALL 2 | |
| Blatt/Sheet | 5 | Profil/Profile | 4.0x11.4 |
| | | Datum/Date | 05.06.2017 |

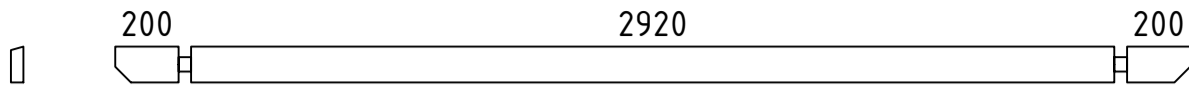
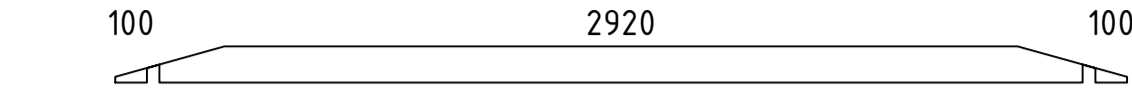
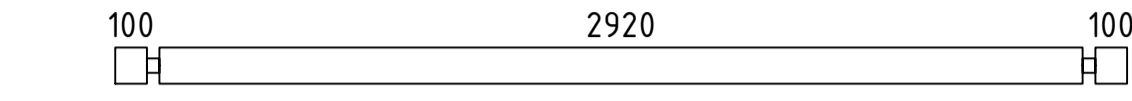
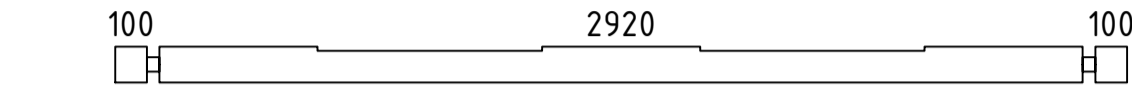
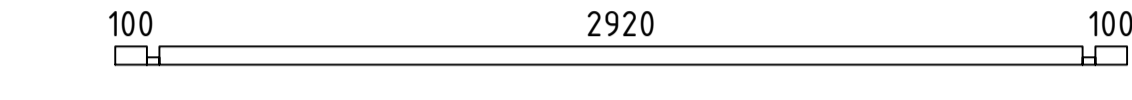
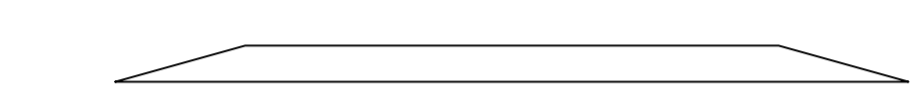
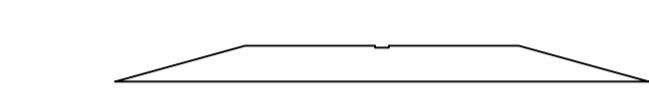
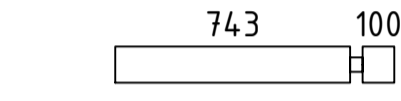
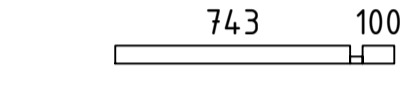
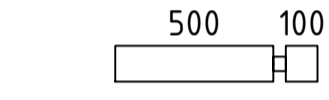
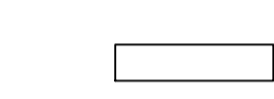
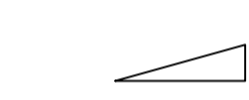
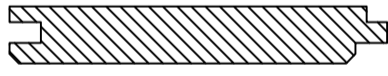
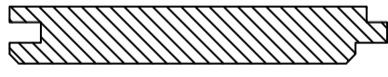
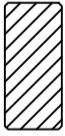
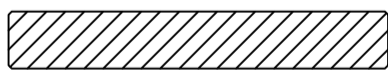
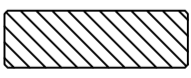
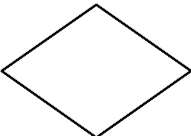
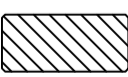
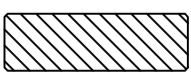
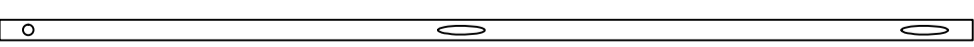
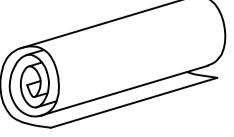
| Pos | Teileliste/Specification Nora F 320x320/40 | | Stck. Pcs. | Profil Profile (mm) | Länge Length (mm) |
|------|---|---|---------------|---------------------------|-------------------------|
| 001 |  | | 2 | 40x114 | 3400 |
| 002 |  | | 2 | 40x114 | 3200 |
| 003 |  | | 46 | 40x114 | 3200 |
| 004 |  | | 1 | 40x114 | 3200 |
| 005 |  | | 1 | 40x57 | 3200 |
| 006 |  | | 2 | 40x114 | 2509 |
| 007 |  | | 2 | 40x114 | 1687 |
| 008 |  | | 34 | 40x114 | 883 |
| 009 |  | | 2 | 40x57 | 883 |
| 010 |  | | 8 | 40x114 | 640 |
| 011 |  | | 4 | 40x114 | 500 |
| 012 |  | | 4 | 40x114 | 411 |
| FH2 | FUNDAMENTHOLZ (imprägniert) - FOUNDATION BEAM (impregnated) | | 2 | 65x44 | 3000 |
| FH1 | FUNDAMENTHOLZ (imprägniert) - FOUNDATION BEAM (impregnated) | | 6 | 65x44 | 2870 |
| DB1 | DACHBALKE - ROOF BEAM | | 3 | 44x145 | 3400 |
| | DACHBRETTER - ROOF BOARDS |  | 62+1 | 113x18 | 1765 |
| | FUSSBODENBRETTER - FLOOR BOARDS |  | 26+1 | 113x18 | 2915 |
| | FUSSBODENLEISTE - FLOOR STRIPS |  | | 18x40 | 12,0 lfm/rm |
| G1-1 | GIEBELBRETTER - GABLE BOARDS 120X18 |  15,5° | 4 | 120x18 | 1845 |
| G5-1 | GIEBELDECKLEISTE - GABLE COVER STRIPS 58X18 |  | 4 | 58x18 | 1845 |
| GS | GIEBELSEGMENT - GABLE DIAMOND |  | 2 | | |
| T4-1 | TRAUFENLEISTE - EAVES STRIPS 40x18 |  | | 40x18 | 7,0 lfm/rm |
| T3-1 | TRAUFENLEISTE - EAVES STRIPS 58x18 |  | 2 | 58x18 | 3400 |
| SM-1 | Sturmleisten - Storm reinforcement |  | 4 | 40x18 | 1940 |
| | DACHPAPPE - ROOFING FELT |  | | 3,4m-4st. | 13,6 lfm/rm |
| Kood | Nora F 320x320/40 | Materjal | File | | Leht 1/2 |

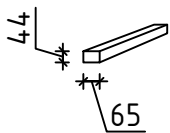
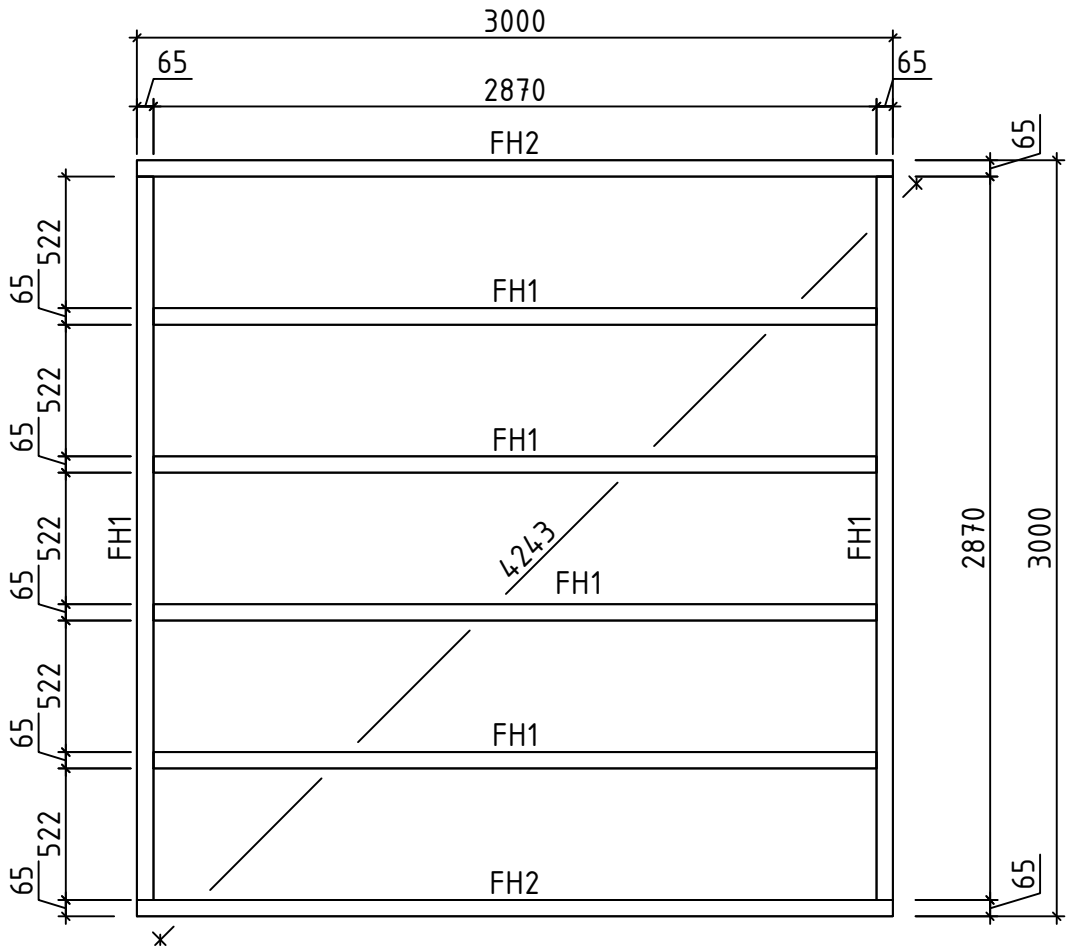

| | | | |
|-------------------|---------------------------------|----------|-----------------------|
| Name | Nora F 320x320/40 | | |
| Zeichnung/Drawing | Lagerholzplan; Foundation beams | | |
| Blatt/Sheet | Profil/Profile | 4.0x11.4 | Datum/Date 05.06.2017 |