

Heinz58+VD ISO

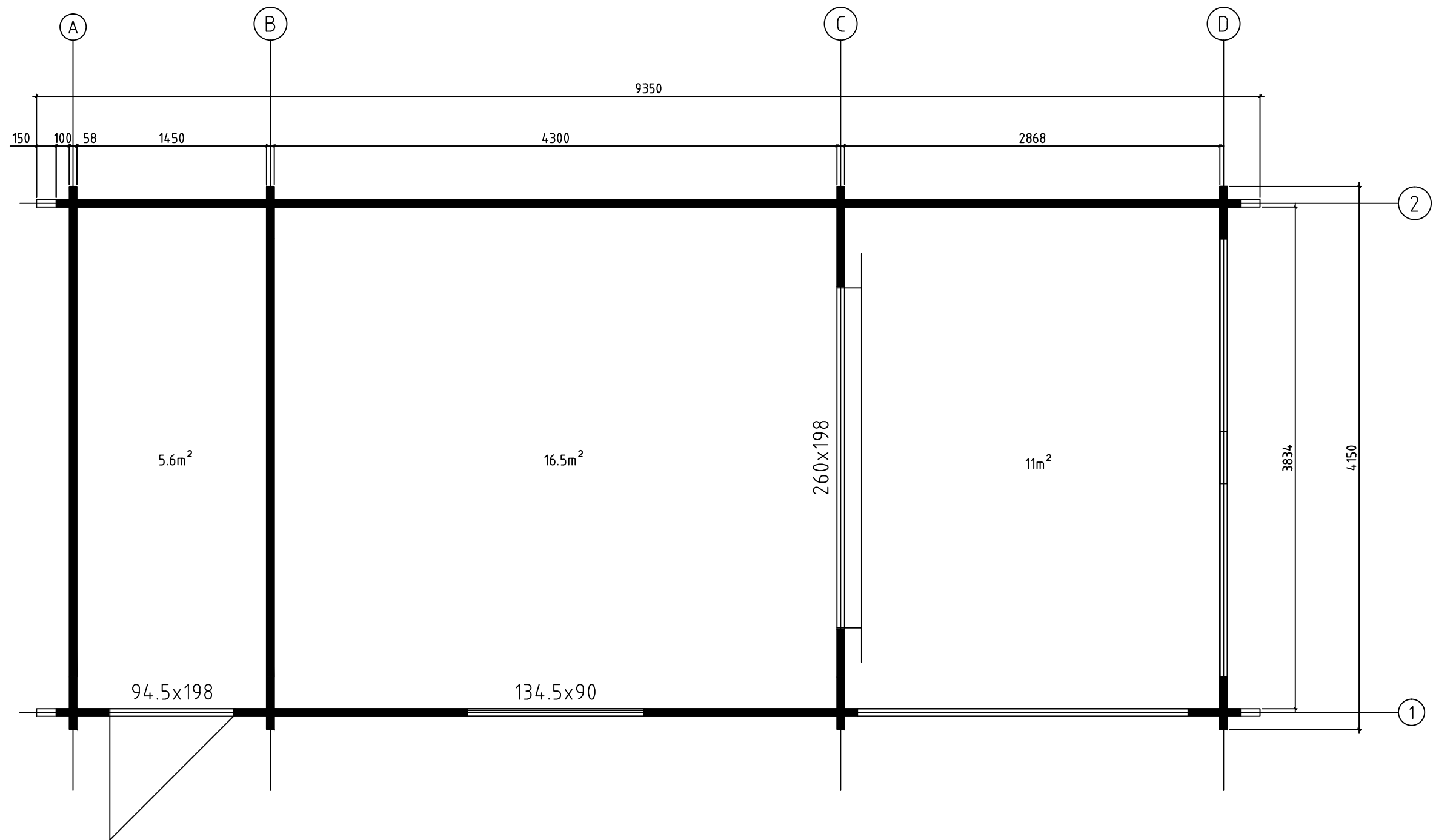

Model	Heinz58+VD ISO	Page	PLAN
Client		Scale	1:50
Material	5.8x13.5	Date	16.08.2017
Company		File	Heinz58+VD ISO.dwg

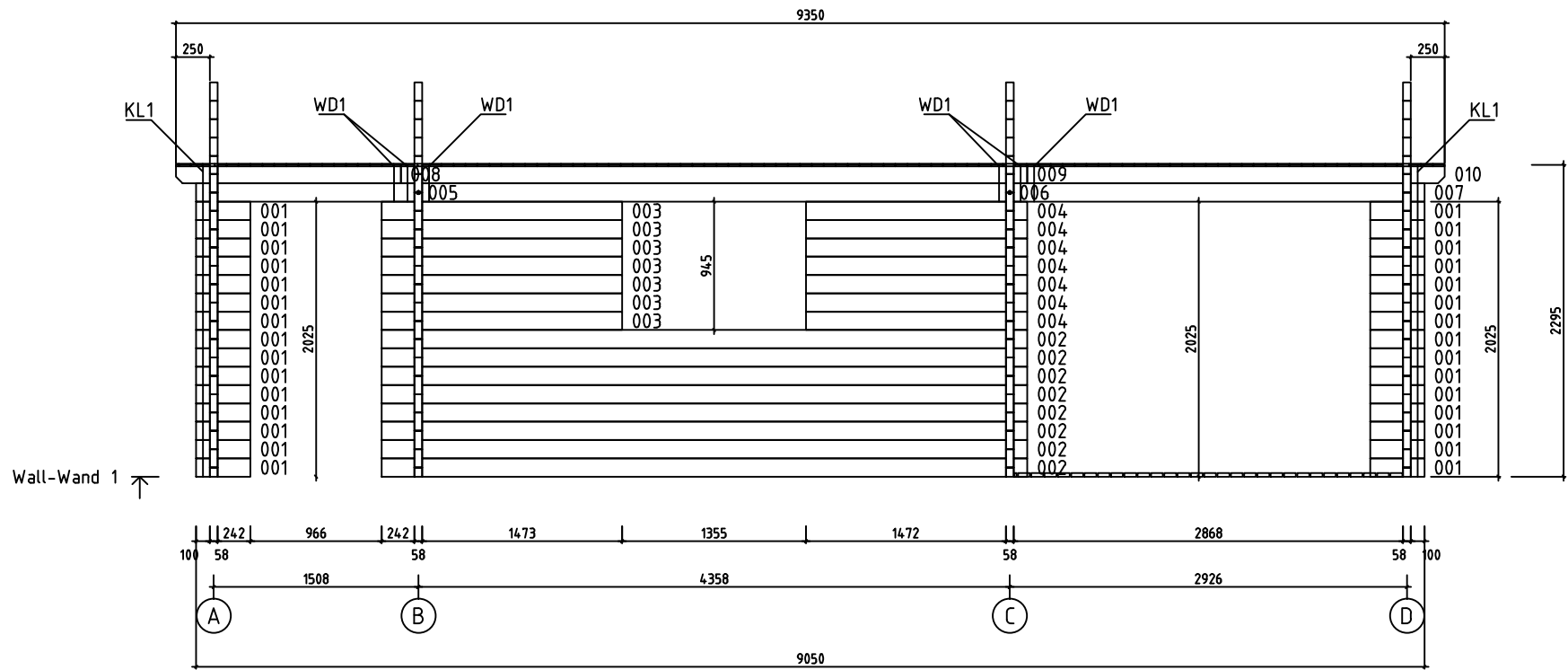

Wall-Wand 1 ↑

Model	Heinz58+VD ISO	Page	6
Client	WALL-WAND 1	Scale	1:50
Material	5.8x13.5	Date	16.08.2017
Company	File Heinz58+VD ISO.dwg		

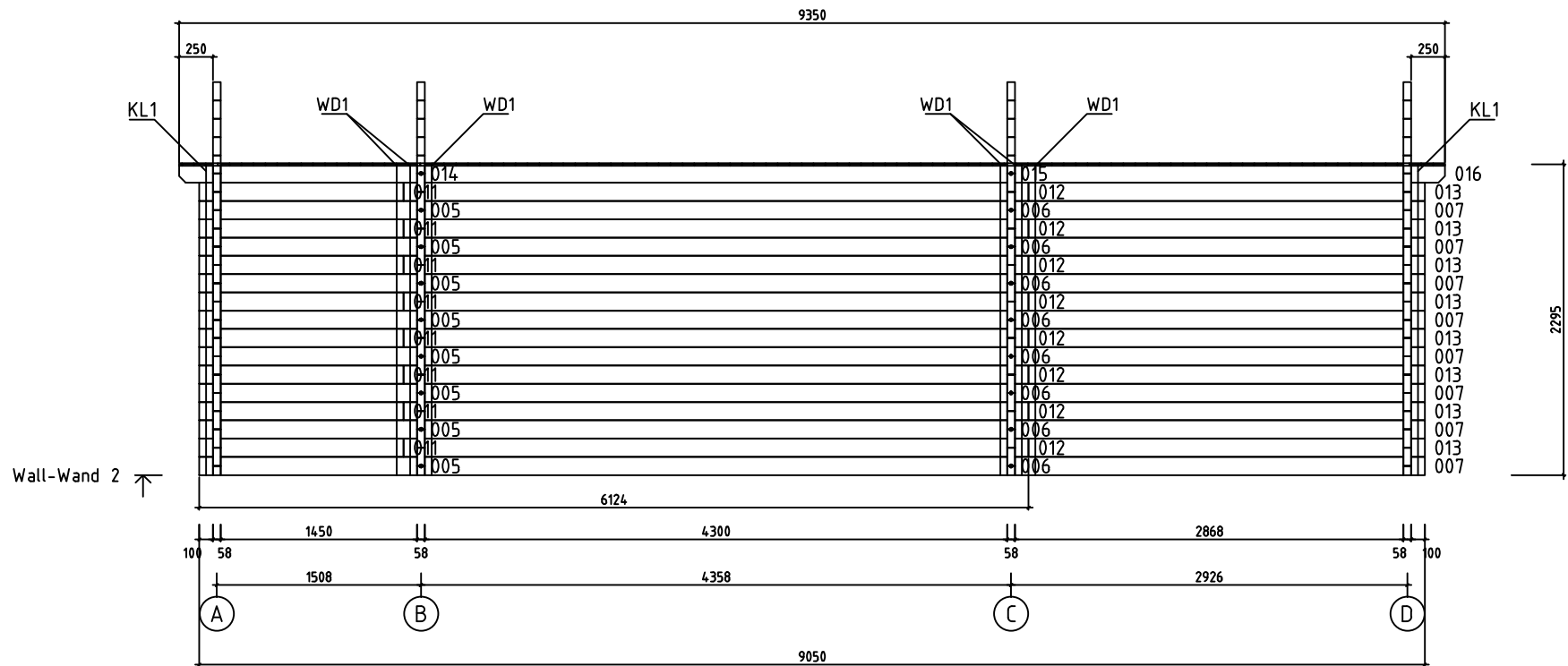

Model	Heinz58+VD ISO	Page	7
Client	WALL-WAND 2	Scale	1:50
Material	5.8x13.5	Date	16.08.2017
Company	File Heinz58+VD ISO.dwg		

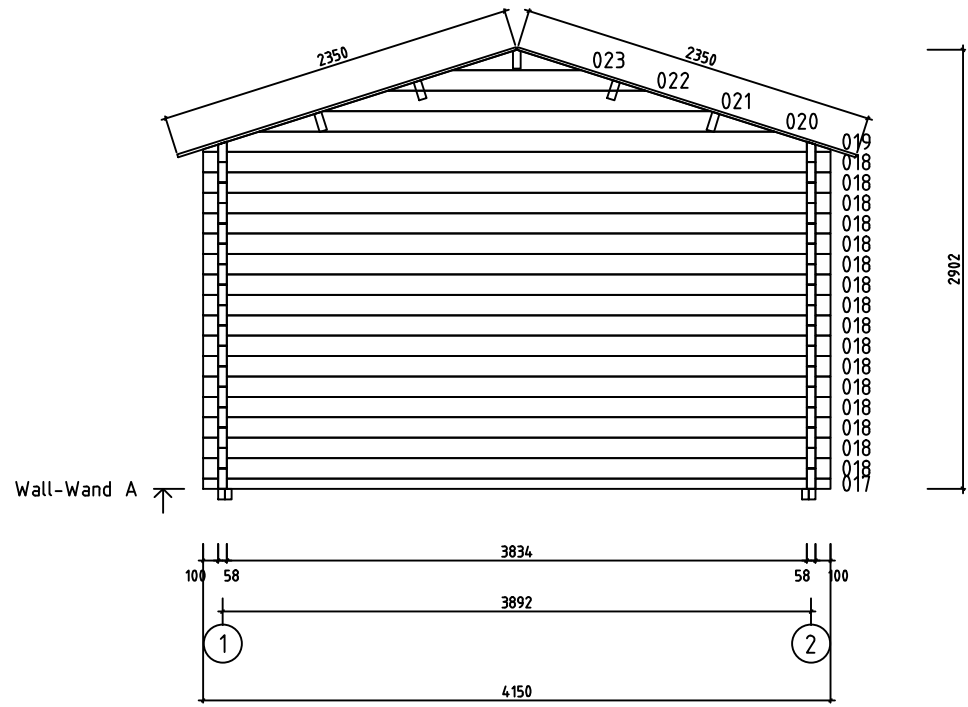

Wall-Wand A

Model	Heinz58+VD ISO	Page	2
Client	WALL-WAND A	Scale	1:50
Material	5.8x13.5	Date	16.08.2017
Company	File Heinz58+VD ISO.dwg		

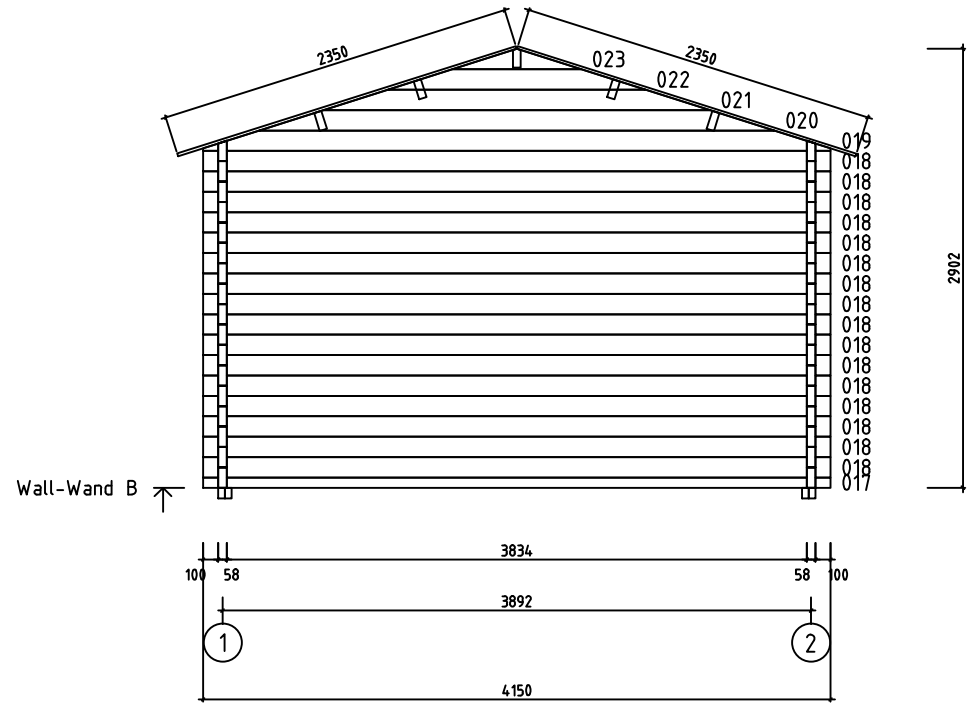

Model	Heinz58+VD ISO	Page	3
Client	WALL-WAND B	Scale	1:50
Material	5.8x13.5	Date	16.08.2017
Company	File Heinz58+VD ISO.dwg		

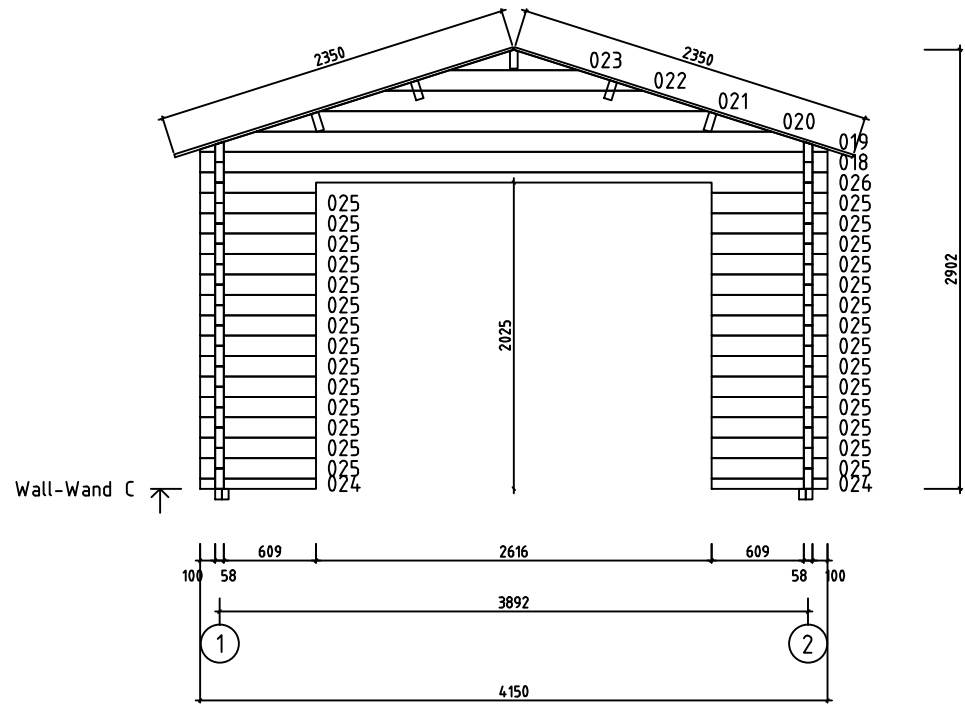



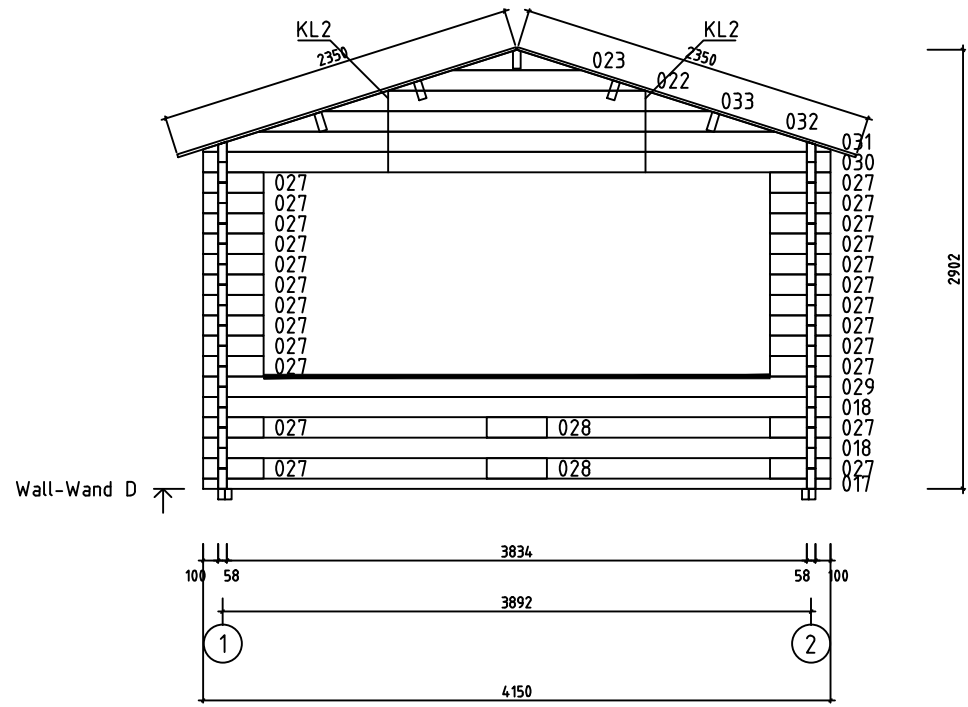





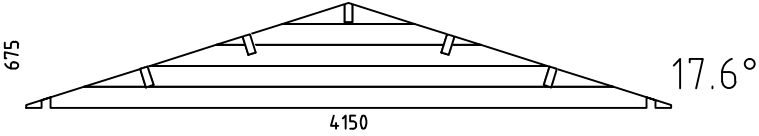
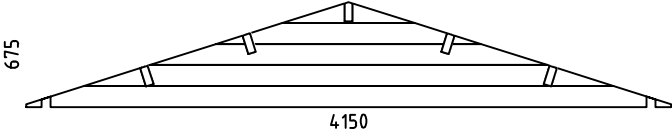
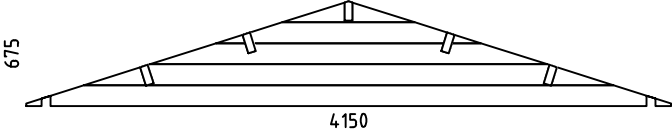
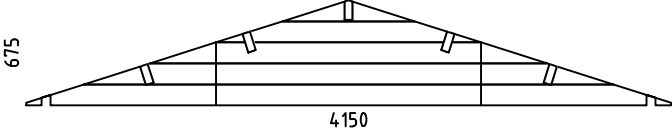
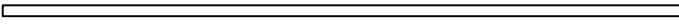
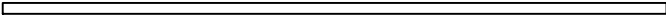
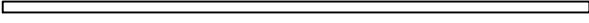
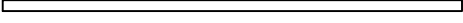
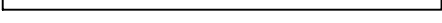
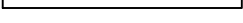
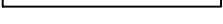
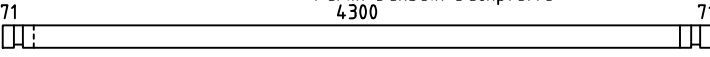
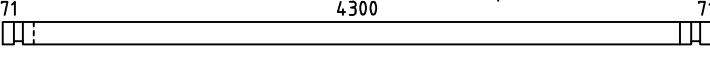
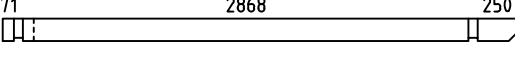
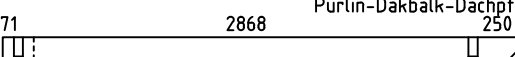
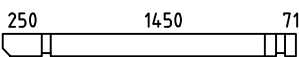
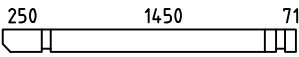
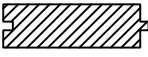
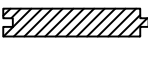













Model	Heinz58+VD ISO	Page	4
Client	WALL-WAND C	Scale	1:50
Material	5.8x13.5	Date	16.08.2017
Company		File	Heinz58+VD ISO.dwg

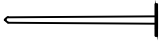

Model	Heinz58+VD ISO	Page	5
Client	WALL-WAND D	Scale	1:50
Material	5.8x13.5	Date	16.08.2017
Company	File Heinz58+VD ISO.dwg		

Pos	Specification-Spezifikation-Specificatie Heinz58+VD ISO	St.	Profile (mm)	Length (mm)
001	100 242 	30	58x135	400
002	242 4300 100 	8	58x135	4758
003	242 1473 	7	58x135	1773
004	1473 100 	7	58x135	1631
005	100 1450 	9	58x135	1637
006		9	58x135	4358
007	2868 100 	9	58x135	3055
008	250 1350 	1	58x135	1658
009	100 4300 100 	1	58x135	4616
010	2768 250 	1	58x135	3076
011	100 1350 	8	58x135	1508
012	100 4300 100 	8	58x135	4616
013	2768 100 	8	58x135	2926
014	250 1450 	1	58x135	1787
015		1	58x135	4358
016	2868 250 	1	58x135	3205
017	100 3834 100 	3	58x68	4150
018	100 3834 100 	35	58x135	4150
024	609 100 	2	58x68	767
025	609 100 	28	58x135	767
026	100 3834 100 	1	58x135	4150
027	242 100 	24	58x135	400
028		2	58x135	400
029	100 3834 100 	1	58x135	4150
030	100 3834 100 	1	58x135	4150

Pos	Specification-Spezifikation-Specificatie Heinz58+VD ISO	St.	Profile (mm)	Length (mm)
WA-1		1		
WB-1		1		
WC-1		1		
WD-1		1		
FB3	FOUNDATION BEAM-FUND.BALKEN-FUND.BALK 	4	44x70	4358
FB6	FOUNDATION BEAM-FUND.BALKEN-FUND.BALK 	6	44x70	4270
FB1	FOUNDATION BEAM-FUND.BALKEN-FUND.BALK 	8	44x70	3774
FB4	FOUNDATION BEAM-FUND.BALKEN-FUND.BALK 	4	44x70	2955
FB7	FOUNDATION BEAM-FUND.BALKEN-FUND.BALK 	6	44x70	2823
FB2	FOUNDATION BEAM-FUND.BALKEN-FUND.BALK 	4	44x70	1537
FB5	FOUNDATION BEAM-FUND.BALKEN-FUND.BALK 	6	44x70	1405
PR2	Purlin-Dakbalk-Dachpfette 4300 	4	58x144	4558
PR5	Purlin-Dakbalk-Dachpfette 4300 	1	58x144	4558
PR3	Purlin-Dakbalk-Dachpfette 2868 250 	4	58x144	3305
PR6	Purlin-Dakbalk-Dachpfette 2868 250 	1	58x144	3305
PR1	Purlin-Dakbalk-Dachpfette 1450 250 71 	4	58x144	1887
PR4	Purlin-Dakbalk-Dachpfette 1450 250 71 	1	58x144	1887
	Floor board-Fussbodenbrett-Vloerplank 	66	88x28	3824
DP1	Roof board-Dachbrett-Dakplank 	214	88x18	2350
	Terrace board-Terrassendiele-Vlonderplank 	30	88x26	3887
	Base Board-FussbLeiste-Plinten 	2	18x40	1450
Kood	Heinz58+VD ISO	Materjal	File Heinz58+VD ISO.dwg	Leht 2/4

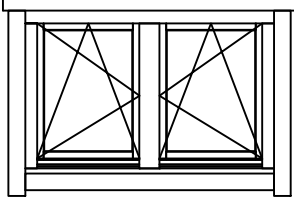
Pos	Specification-Spezifikation-Specificatie Heinz58+VD ISO	St.	Profile (mm)	Length (mm)
	Base Board-FussbLeiste-Plinten 	4	18x40	3834
	Base Board-FussbLeiste-Plinten 	2	18x40	4300
L1	Eave Board-Traufenblende-Afdekplank 	4	18x120	4675
L2	Eave Slat-Traufenleiste-Afdeklijst 	4	40x18	4675
L3	Facia Board-Giebelblende-Gevelplank 	4	18x120	2390
L4	Facia Slat-Giebelleiste-Gevellijst 	4	40x18	2390
HL1	Handrail-Handlauf 	1	95x18	3350
KL2	Threaded rod Set-Gewindestange Satz-Draadstang Set 	2		580
KL1	Threaded rod Set-Gewindestange Satz-Draadstang Set 2 	4		2350
D1	Diamond 	2		
	Door Set-Tür Satz-Deur Set 	1		
	Nail-Nagel-Spijker 	2400		
	Roofing Felt Nail-Dachpappe Nagel-Dakleer Spijker 	700		
	Roofing Felt-Dachpappe-Dakleer 	3.5		
	Screw-Schraube-Schroef 4x50 	95		
	Screw-Schraube-Schroef 6x120 	70		
	Sliding Door Set-Schiebetür Satz-Schuifdeur Set 	1		
WD1	Wall Dowel-Wanddübel-Muurplug 	65		
	Window Handle Set-Fenstergriff Satz-Raamgreep Set 	2		
DW06DK 134.5 X90 ISO	WINDOW 1345x900 ISO 	1		
Kood	Heinz58+VD ISO	Materjal	File Heinz58+VD ISO.dwg	Leht 3/4

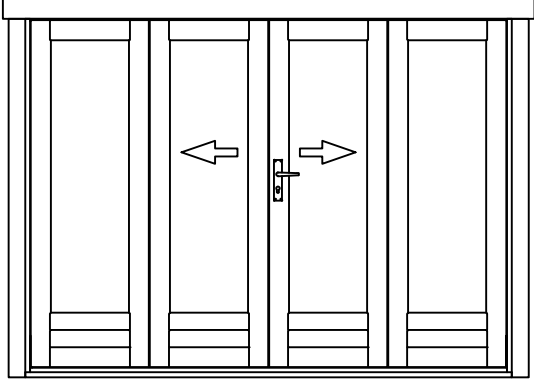
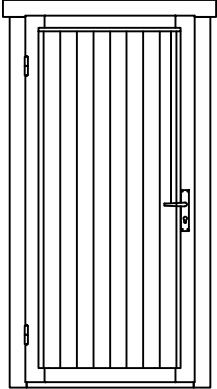
Pos	Specification-Spezifikation-Specificatie Heinz58+VD ISO	St.	Profile (mm)	Length (mm)
4ST08 260x 198 ISO	<p style="text-align: center;">DOOR 2600x1980 ISO</p> 	1		
SDL 94.5 x198 L	<p style="text-align: center;">DOOR 945x1980</p> 	1		
Kood Heinz58+VD ISO	Materjal	File Heinz58+VD ISO.dwg	Leht 4/4	

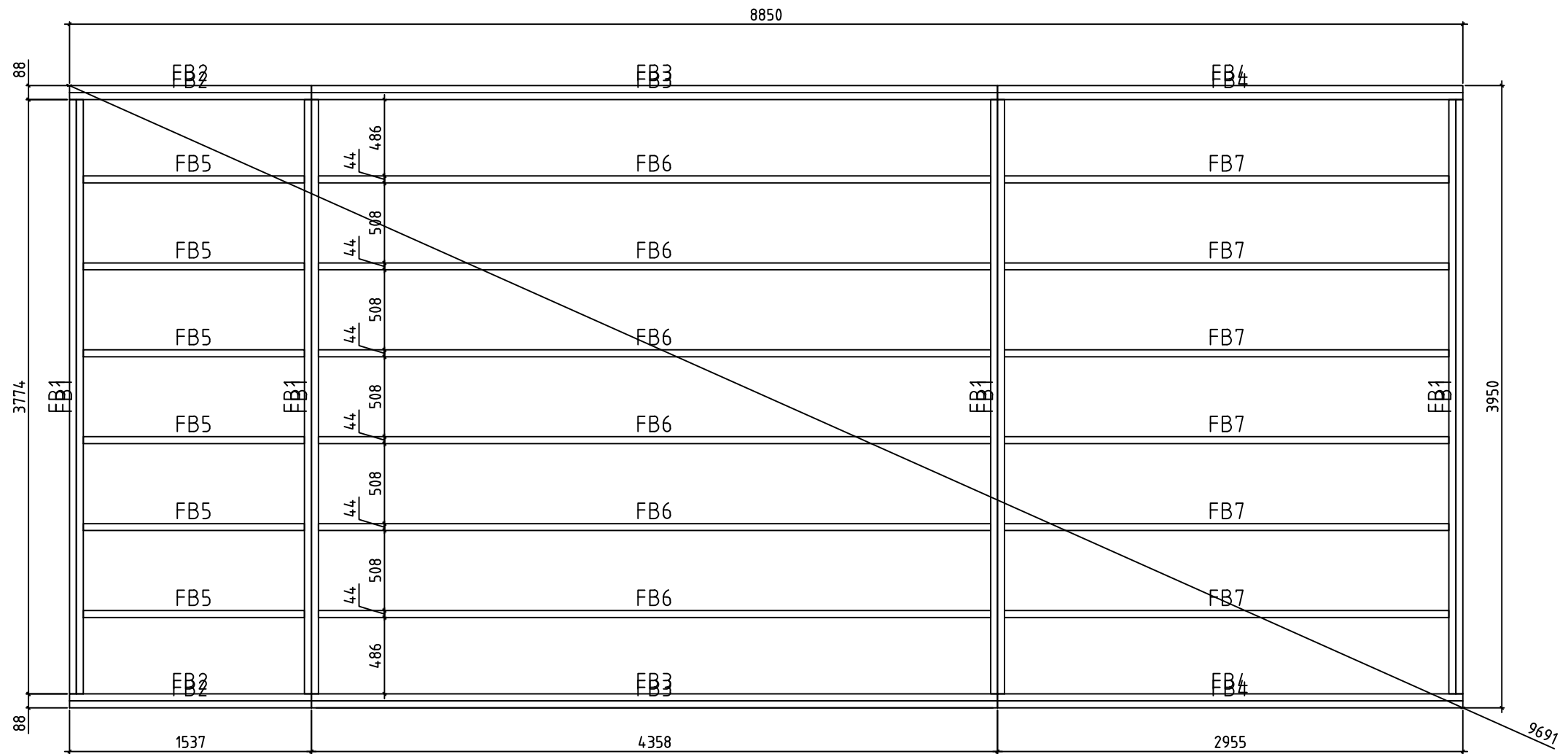

Model	Heinz58+VD ISO	Page	FOUNDATION
Client		Scale	1:50
Material	5.8x13.5	Date	16.08.2017
Company		File	Heinz58+VD ISO.dwg

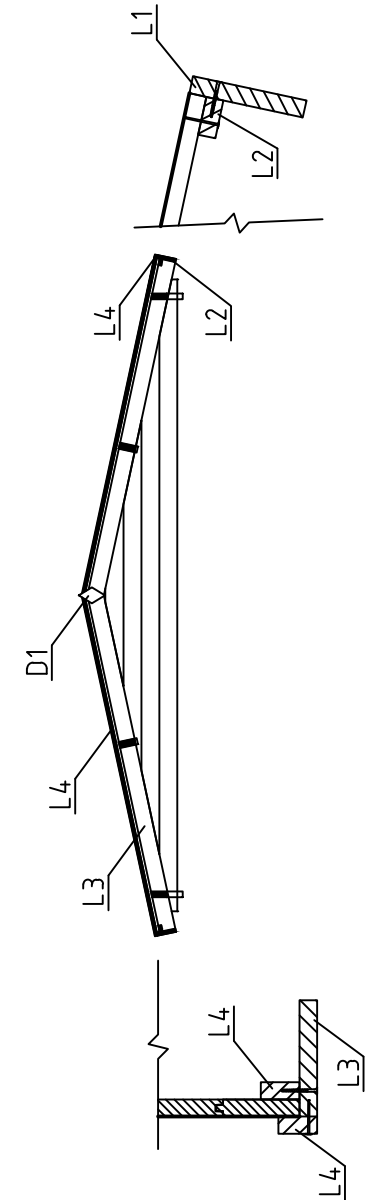
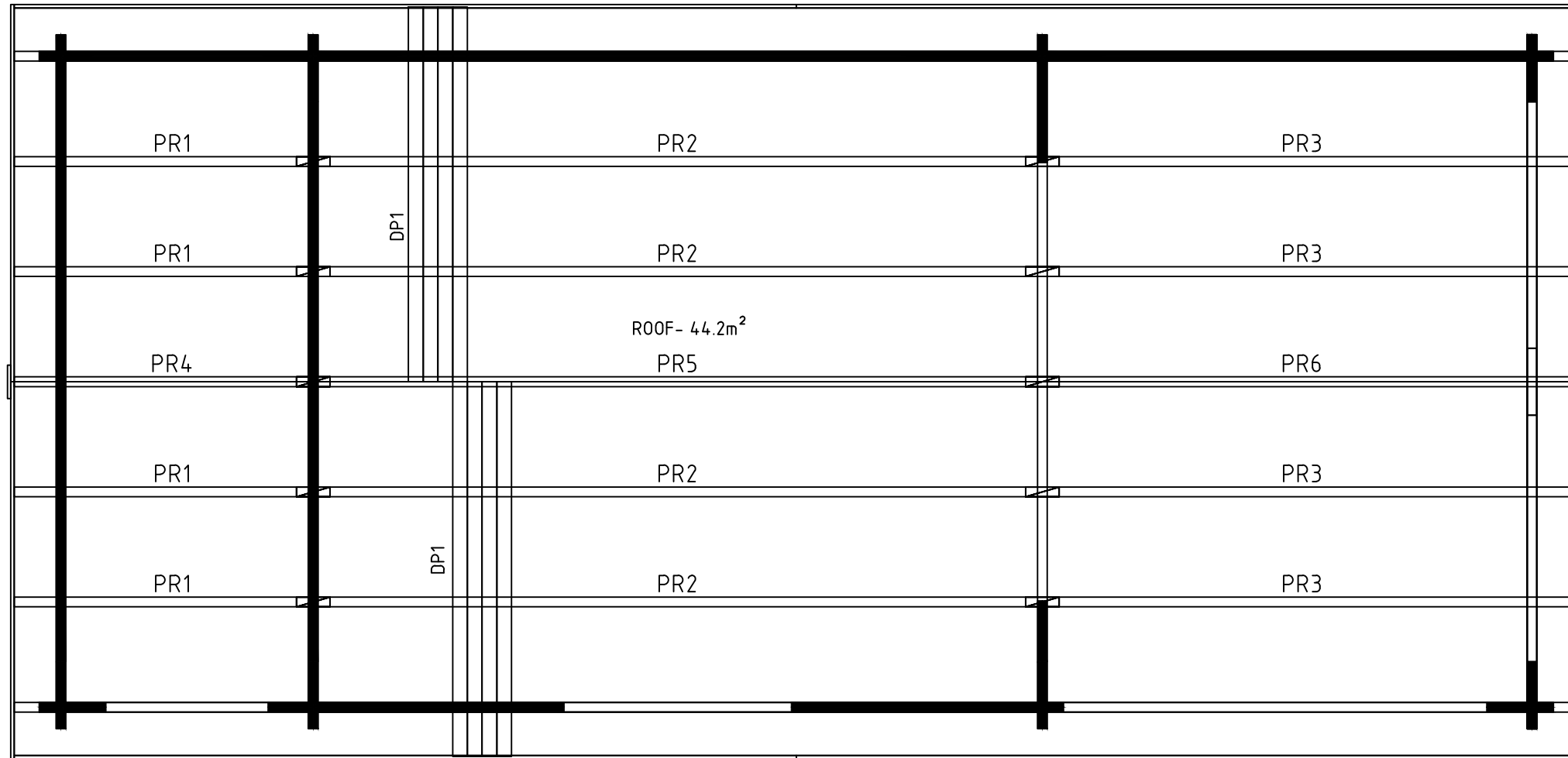

Model	Heinz58+VD ISO	Page	ROOF
Client		Scale	1:50
Material	5.8x13.5	Date	16.08.2017
Company		File	Heinz58+VD ISO.dwg