

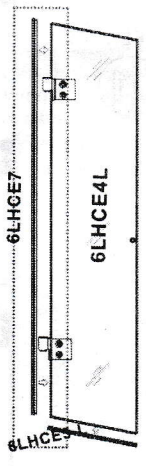

6

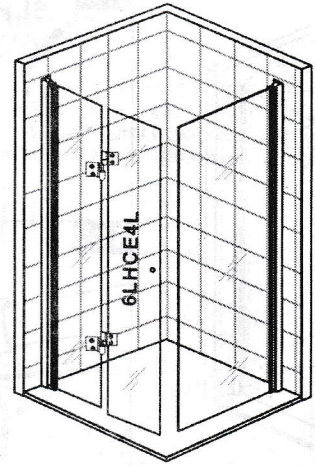

7



6.1

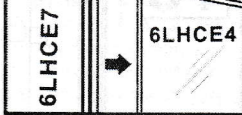

6.2

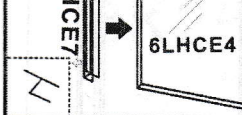

6.3



7.1

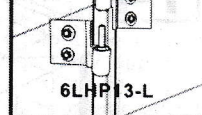

7.2

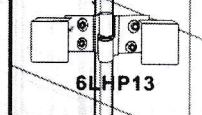

7.3

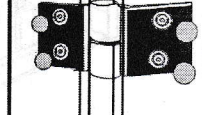

8

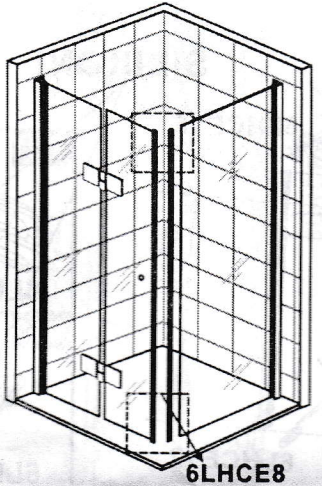

8.1



8.2



9

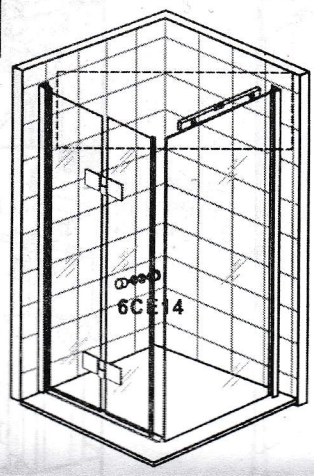

9.1

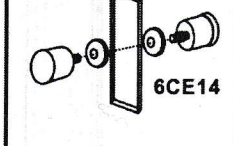

9.2

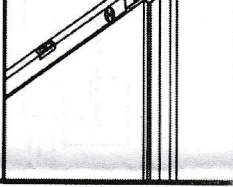

10

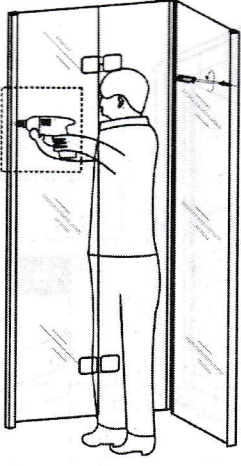

10.1

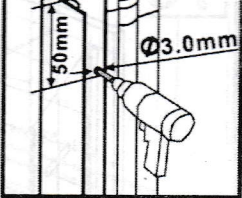

10.2

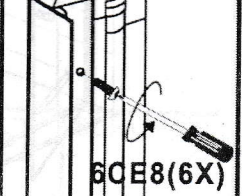

11

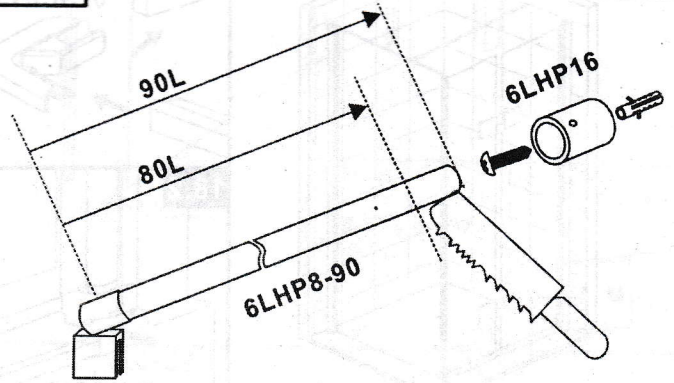

12

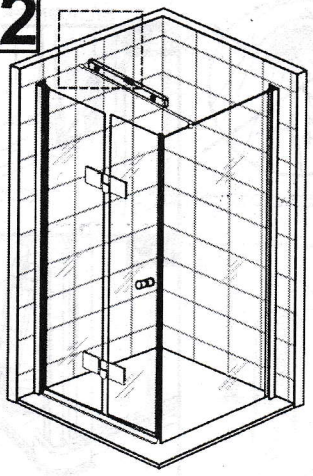

12.1

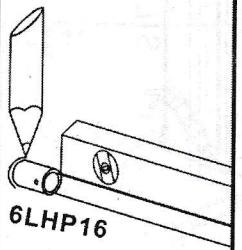

13

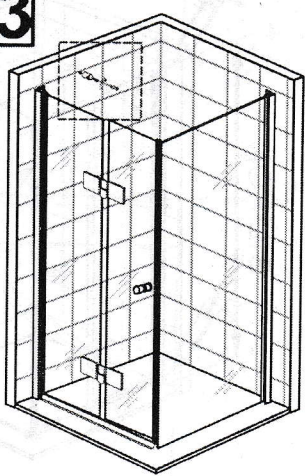

13.1

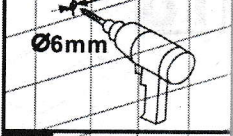

13.2

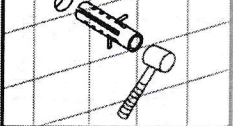

13.3





**14**

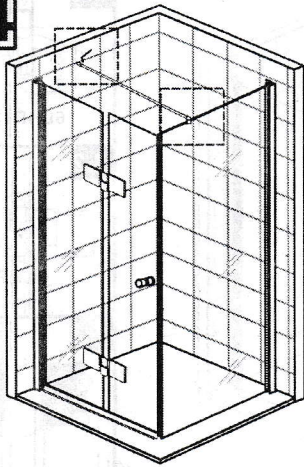

**14.1**

6LHP17

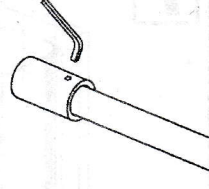

**14.2**

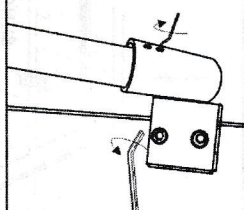

**15**

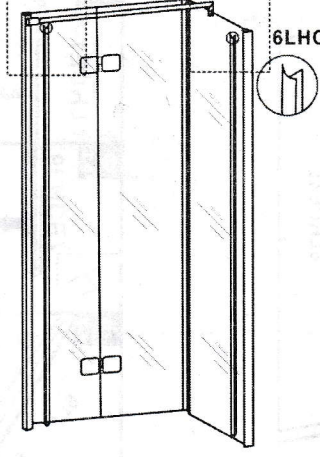

6LHCE2

**15.1**

6LHCE2

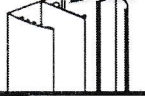

**15.2**

6LHCE1

6LHCE2

**15.3**

6LHCE1

6LHCE2

**16**

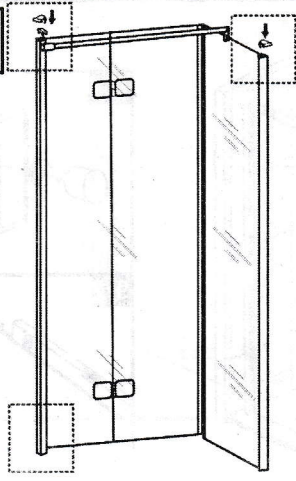

**16.1**

6LHCE10  
6LHCE19

**16.2**

6LHCE10

**16.3**

6LHP17

**17**

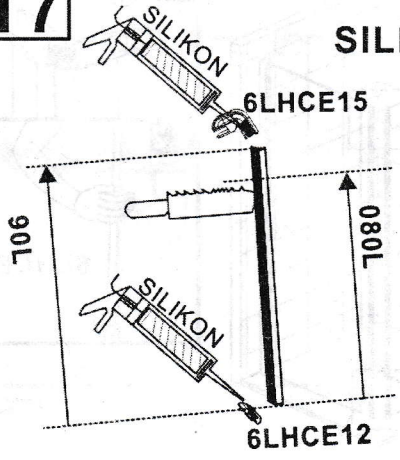

**SILIKON!**

**17.1**



6LHCE15

**17.2**



6LHCE12

**18**

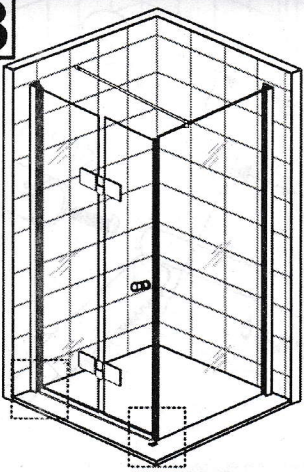

**18.1**

6LHCE15

**18.2**

6LHCE12

**19**

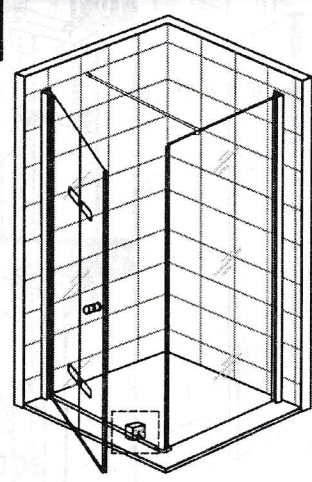

**19.1**



**18**

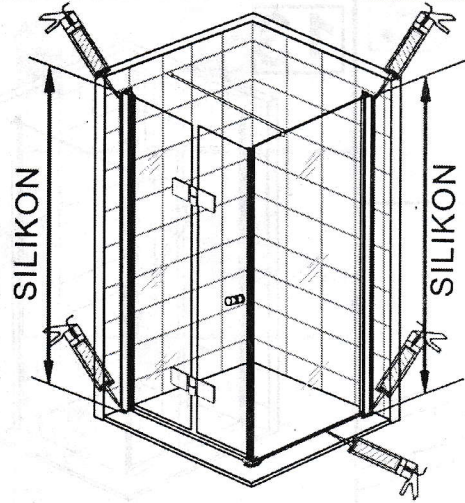

**18.1**

SILIKON

**18.2**

